

Lecture 05

BLE Connections

CS397/497 – Wireless Protocols for IoT
Branden Gena – Winter 2021

Today's Goals

- Explore how connections work
 - What does the link layer look like?
 - How do higher layers interact to share data?
- Investigate network questions about connections
- Overview of additions in BLE 5.0

Useful documentation

- [[5.2 specification](#)] [[4.2 specification](#)] (link to PDF download)
- <https://www.novelbits.io/deep-dive-ble-packets-events/>
- Thinking about BLE connection data transfer rates
 1. <https://punchthrough.com/maximizing-ble-throughput-on-ios-and-android/>
 2. <https://punchthrough.com/maximizing-ble-throughput-part-2-use-larger-att-mtu-2/>
 3. <https://punchthrough.com/maximizing-ble-throughput-part-3-data-length-extension-dle-2/>

Outline

- **Connection Link Layer**
- Connection Investigations
- GATT

- BLE 5

Overview of connections

- Connections are for bi-directional communication with higher throughput than advertisements
- Simple view
 - A peripheral is either advertising or in a connection
 - A central is scanning and in one or more connections
 - (Remember: actually false, devices can have many roles simultaneously)
- While in a connection both devices act like servers
 - Either device can read/write fields available on the other device

Connection timeline (in picture form)

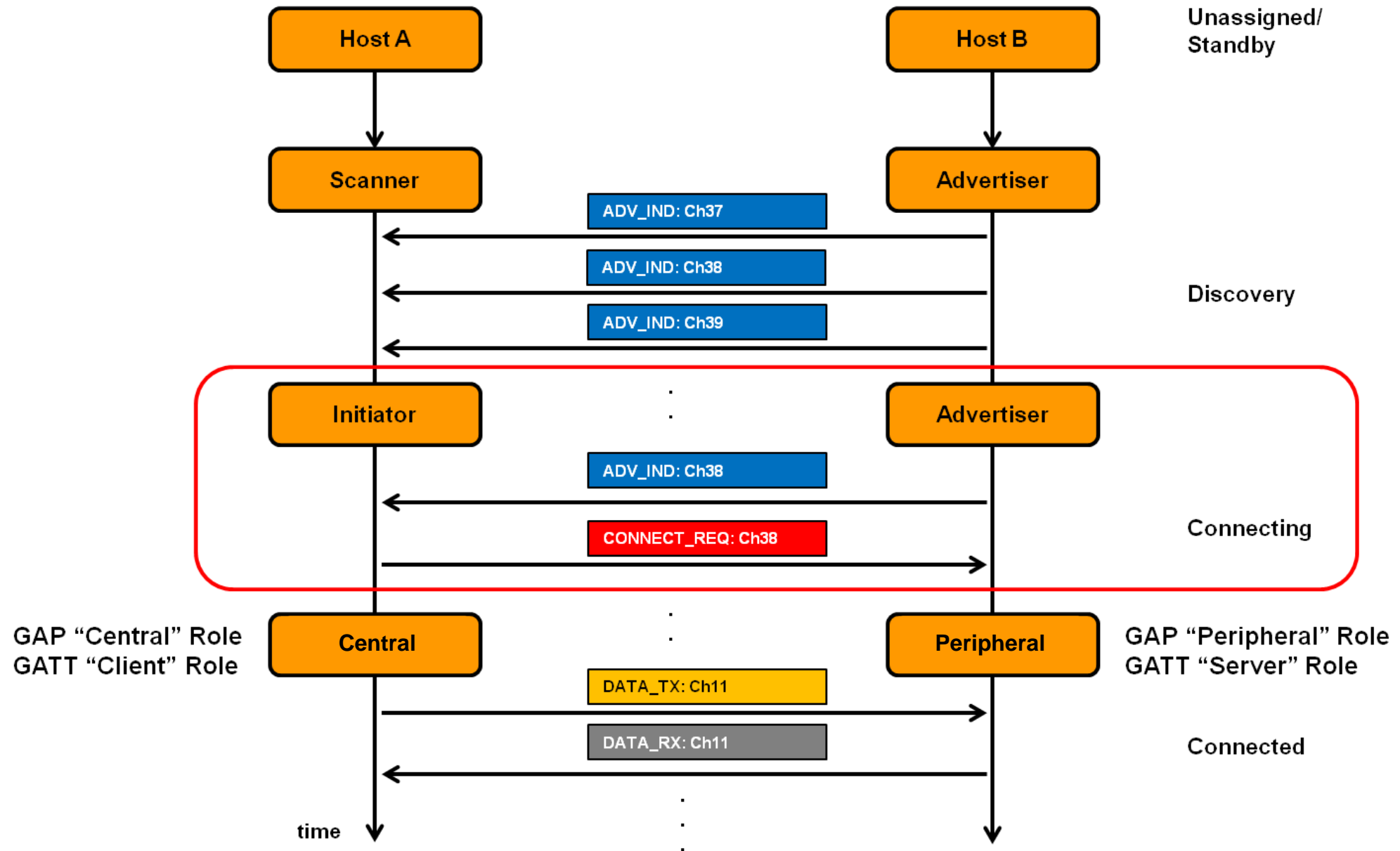

Connection timeline

- Initiating a connection
 - Peripheral is sending broadcast advertisements
 - Central is scanning and receives an advertisement
 - Central sends connection request
- During a connection
 - Central sends a packet each “connection interval”
 - Peripheral immediately responds with a packet
 - Multiple packets may be exchanged this way until done
 - Repeat at next connection interval
- Ending a connection
 - Either device sends termination packet
 - Timeout occurs on either device

Connection request packet

- Scanner waits until it sees an advertisement from a device it wants to connect to
 - Requesting a connection (in higher layers) just starts this search process
- Sends connection request payload in response to advertisement

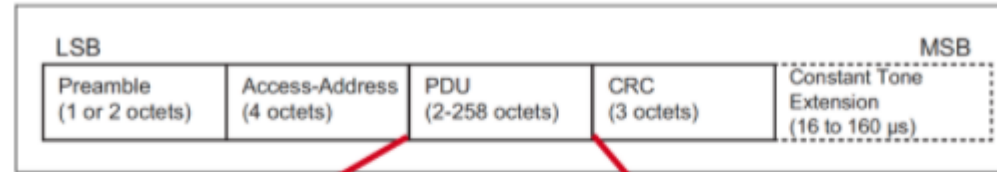

Figure 2.1: Link Layer packet format for the LE Uncoded PHY



Figure 2.4: Advertising physical channel PDU

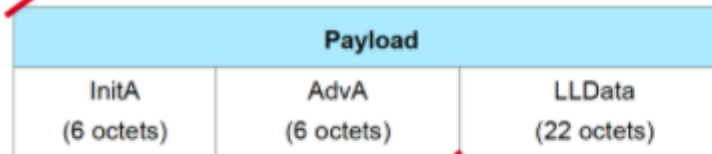
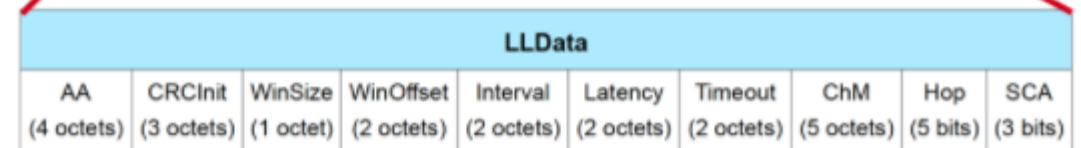

Figure 2.12: `CONNECT_IND` and `AUX_CONNECT_REQ` PDU Payload



Request parameters

LLData									
AA (4 octets)	CRCInit (3 octets)	WinSize (1 octet)	WinOffset (2 octets)	Interval (2 octets)	Latency (2 octets)	Timeout (2 octets)	ChM (5 octets)	Hop (5 bits)	SCA (3 bits)

- Specifies parameters of the connection
 - Peripheral must either agree or totally reject the connection
 - Peripheral can later propose a change to the connection parameters
- Interval is how frequently connection events occur
- Timeout is how long since hearing from a device before the connection breaks
- Channel Map and Hop have to do with FHSS pattern

The Central schedules the first connection event

- WinSize and WinOffset specify start of the first connection event
 - Places an “anchor” point that defines the TDMA schedule for this device
 - Interval specifies duration between connection events starting at “anchor”
 - Allows Central to place this connection, avoiding others it has
 - Before first response from peripheral, timeouts are faster

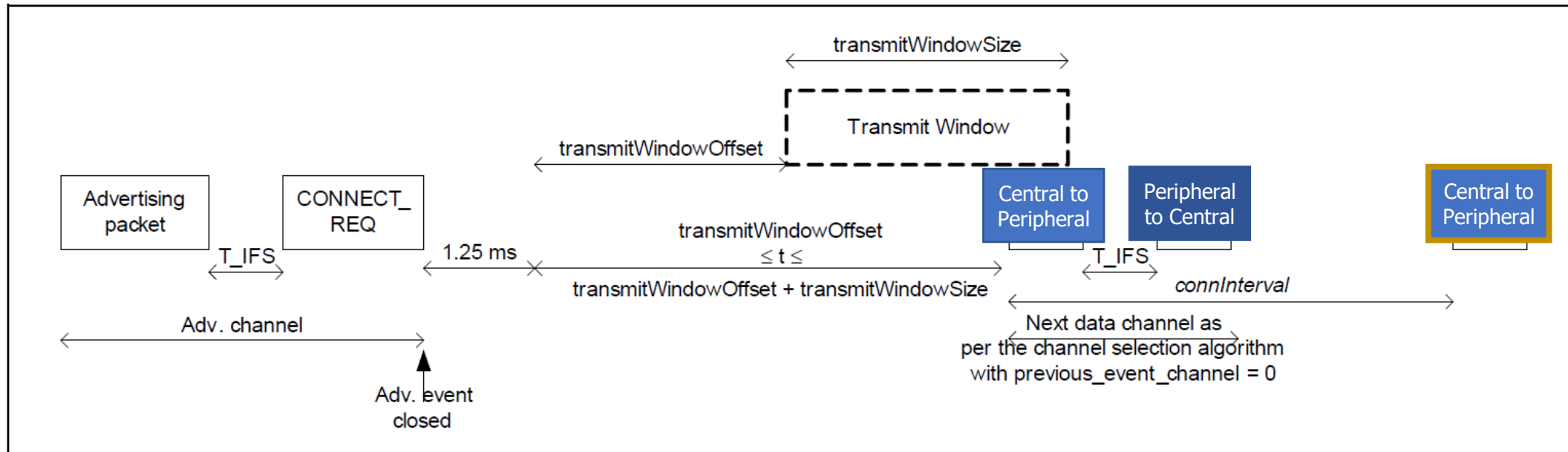

Steady-state connection timing

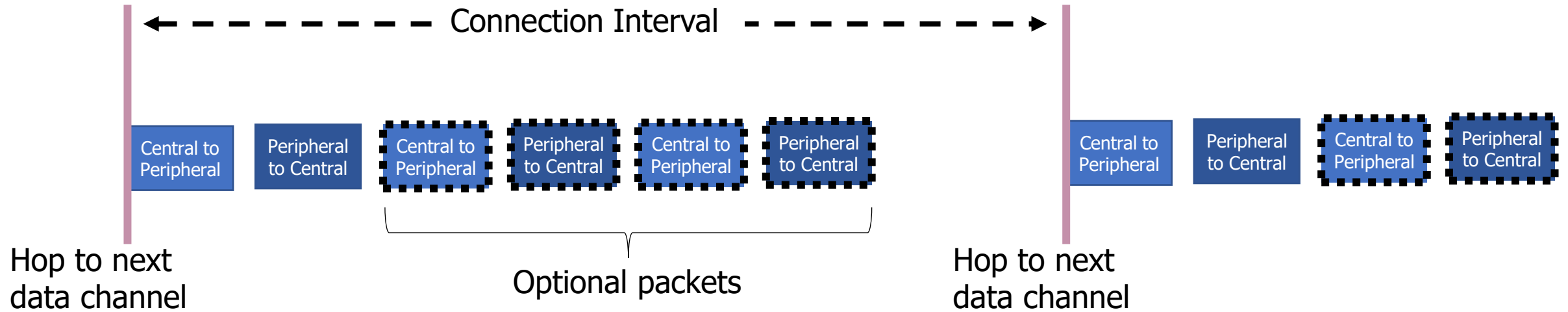

- Some data can be exchanged at each interval
 - Might just be acknowledgements
 - Additional packets can be sent if there is a lot to transmit
 - Each interval is on the next channel in the hopping sequence
- Peripheral can skip a number of intervals to save energy
 - Defined by the Latency connection request parameter

Connection packet layering

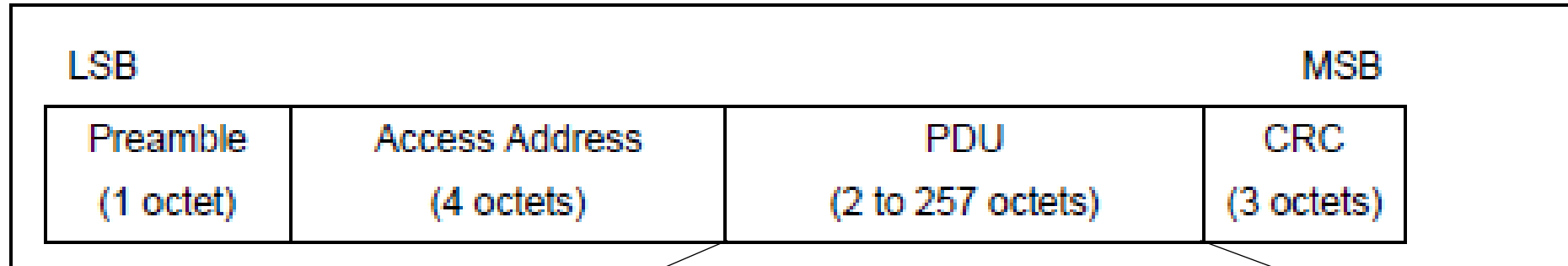

Figure 2.1: Link Layer packet format

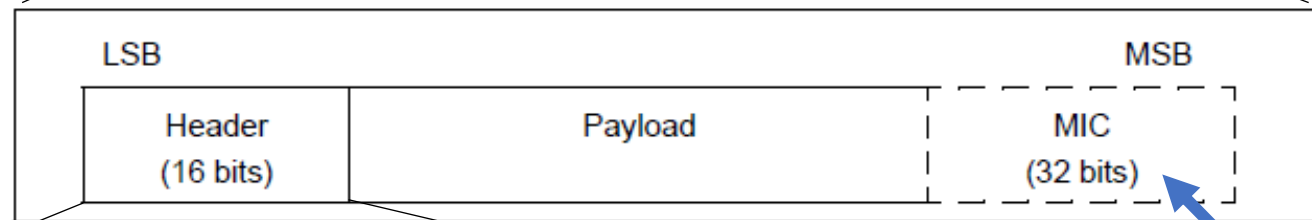

Figure 2.12: Data Channel PDU

- LLID – link layer ID
- Empty data / Fragment
 - Data
 - Control

MD – more data
(continues connection event)

Optional authentication

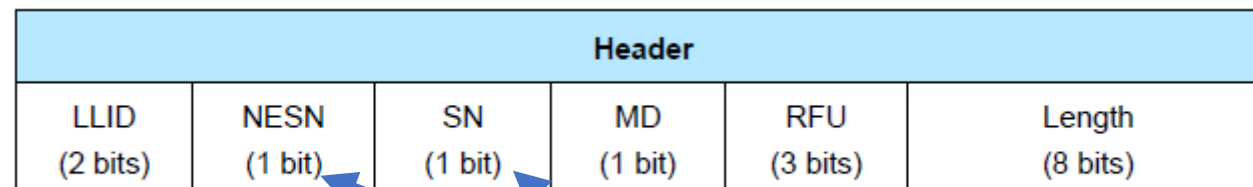

Figure 2.13: Data channel PDU header

Sequence number nonsense

Control payloads

Examples:

- Request update to connection parameters like interval (by peripheral)
- Begin encrypting communication
- Terminate a connection

Opcode	Control PDU Name
0x00	LL_CONNECTION_UPDATE_REQ
0x01	LL_CHANNEL_MAP_REQ
0x02	LL_TERMINATE_IND
0x03	LL_ENC_REQ
0x04	LL_ENC_RSP
0x05	LL_START_ENC_REQ
0x06	LL_START_ENC_RSP
0x07	LL_UNKNOWN_RSP
0x08	LL_FEATURE_REQ
0x09	LL_FEATURE_RSP
0x0A	LL_PAUSE_ENC_REQ
0x0B	LL_PAUSE_ENC_RSP
0x0C	LL_VERSION_IND
0x0D	LL_REJECT_IND
0x0E	LL_SLAVE_FEATURE_REQ
0x0F	LL_CONNECTION_PARAM_REQ
0x10	LL_CONNECTION_PARAM_RSP
0x11	LL_REJECT_IND_EXT
0x12	LL_PING_REQ
0x13	LL_PING_RSP
0x14	LL_LENGTH_REQ
0x15	LL_LENGTH_RSP

Data payloads

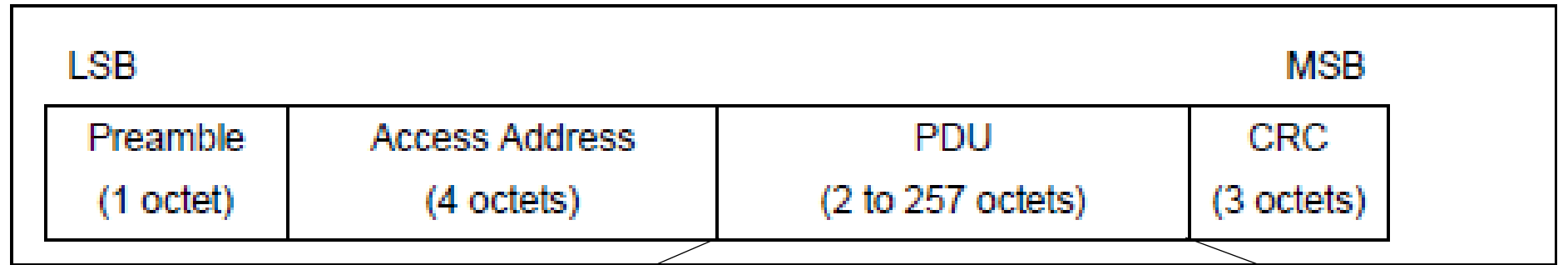

Figure 2.1: Link Layer packet format

SDU – Service Data Unit

- Logical packet that may be split into several physical packets

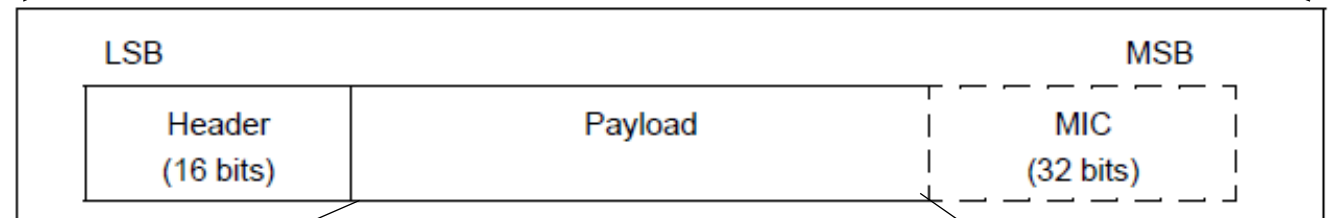
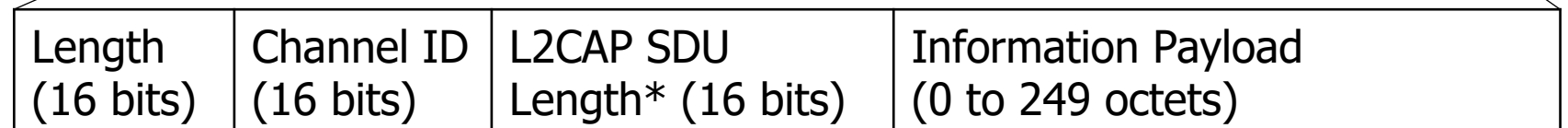

Figure 2.12: Data Channel PDU

Channel ID

- Destination for data
- ATTRIBUTES or Security
- Can also make custom endpoints



Next steps in a connection

- Control packets
 - Version
 - Bluetooth version, Company ID of Software Stack
 - Features
 - Various connection features supported by the device
 - Encryption, Ping, Channel selection algorithms, Various 5.0 features
 - Etc.
 - Extended packet length, Various 5.0 features (change PHY)
 - Various “procedures” for setting up changes in the connection
- Data packets
 - Attribute discovery
 - Attribute reading

Ending connections

- Termination control packet
- Timeout parameter from connection parameters
 - Human-based devices may just wander away from each other
 - Or be shut off, or reprogrammed, etc.

Outline

- Connection Link Layer
- **Connection Investigations**
- GATT

- BLE 5

Questions about how a connection “network” works

- How does TDMA MAC for connections work?
 - Implies a schedule
 - Implies synchronization
- How many devices can be in a network?
- How much throughput can a device have?

How is the TDMA schedule created/managed?

- Only the central needs to know the schedule
 - It controls interactions with the peripheral(s) it is connected to
- Anchor point and connection interval determines the schedule for a specific device

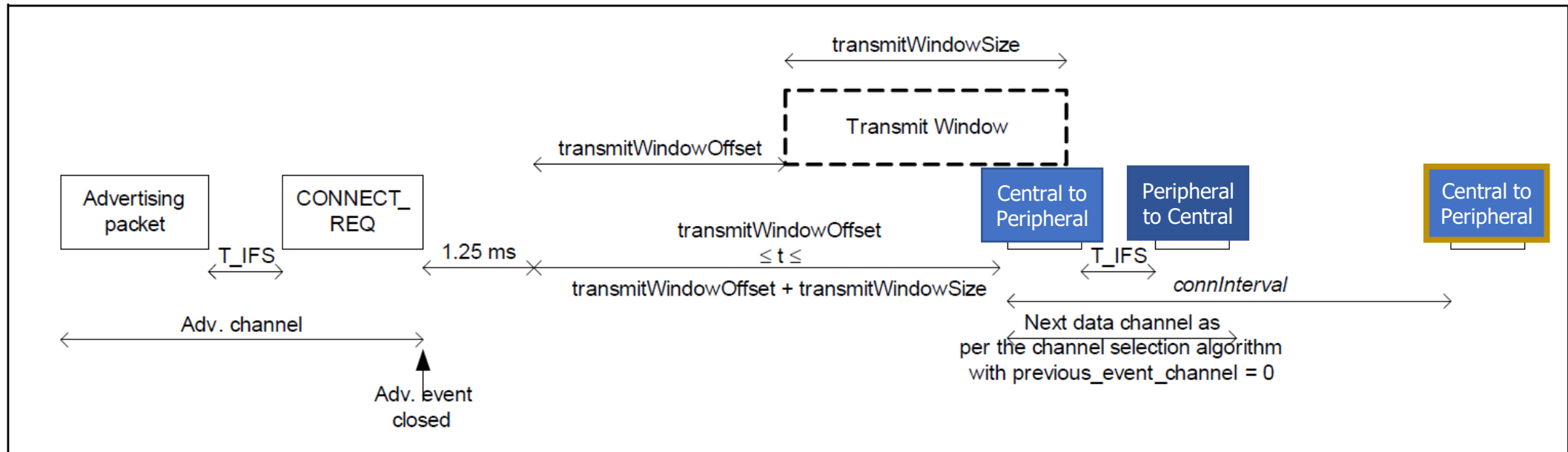

How is synchronization managed?

- Central sends first packet at each connection interval
 - So peripheral must be synchronized to central
 - Resynchronization can occur on each received packet
- Specification describes how a peripheral must widen its listening window based on “Source Clock Accuracy”

$$windowWidening = \left(\frac{centralSCA + peripheralSCA}{1000000} \right) * timeSinceLastAnchor$$

How many devices can be connected?

- We can schedule with granularity of *at least* 1.25 ms (offset steps)
 - That's at least 800 devices per second
- Intervals go up to 4 seconds, so multiply by four
 - That's 3200 devices per max interval
- Plus central can skip intervals on occasion without dropping the connection
 - And really the offset defines a window. More granularity is available
- Answer: thousands of devices
 - Although each is sending minimum-sized packets each interval

How many devices can be connected in the real world?

- The limit is much much lower on real devices
 - Example: Android sets a limit at around 4-15
 - nRF52 s140 softdevice allows up to 20
- Connection management is often done in firmware
 - Softdevice for nRF, firmware on the radio chip in smartphones
- Limited by memory and complexity

How much throughput can a device have?

- **1 Mbps?**

How much throughput can a device have?

- **1 Mbps?** Not even close. Packet overhead plus timing delays
- Step 1: decrease connection interval as much as possible
 - More connection events per second mean more data
 - Range: 7.5 ms to 4.0 s
 - Somewhat device-specific configuration
 - Android allows 7.5 ms
 - iOS allows 15 ms

How much throughput can a device have?

- Step 2, increase packet size

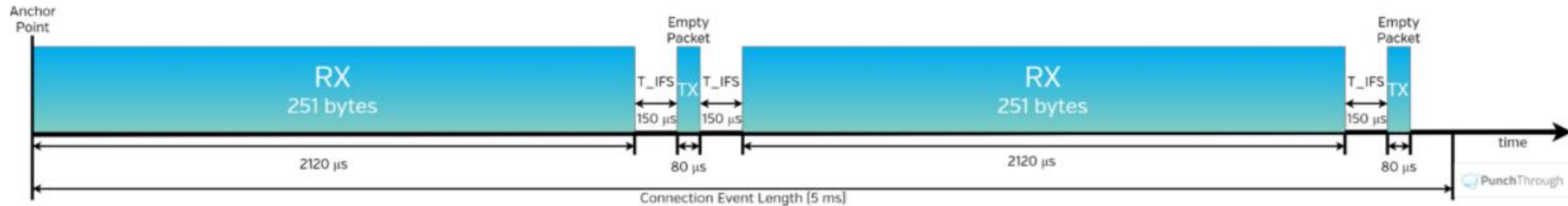

Figure 5 – A single connection event (from the slave's perspective) in a DLE-enabled connection in which the master is transmitting as much data as possible within the effective Connection Event Length

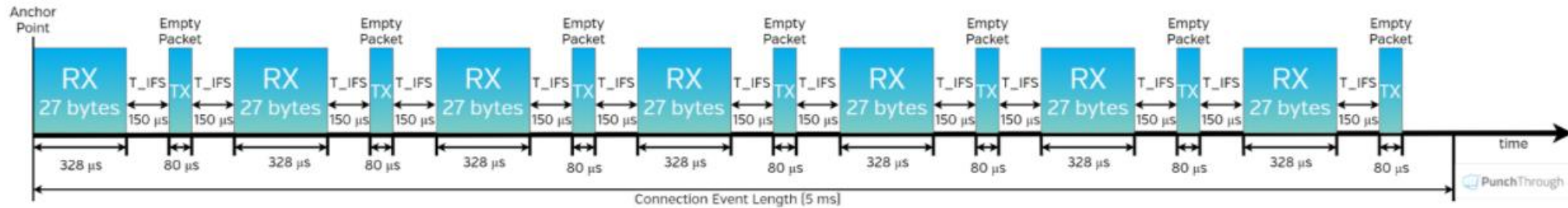

Figure 6 – A single connection event (from the slave's perspective) in a connection without DLE, in which the master is transmitting as much data as possible within the effective Connection Event Length

How much throughput can a device have?

- 488 bytes per connection event
 - Maximum sized packets, discounting headers and timing delays
- Connection event every 7.5 ms
- Result: 520 kbps (65 kB per second)
 - iOS result 260 kbps
 - Original BLE 4.1 result on Android: 128 kbps
 - Lower in practice due to lost packets

Outline

- Connection Link Layer
- Connection Investigations
- **GATT**
- BLE 5

Overview of Generic Attribute Profile (GATT)

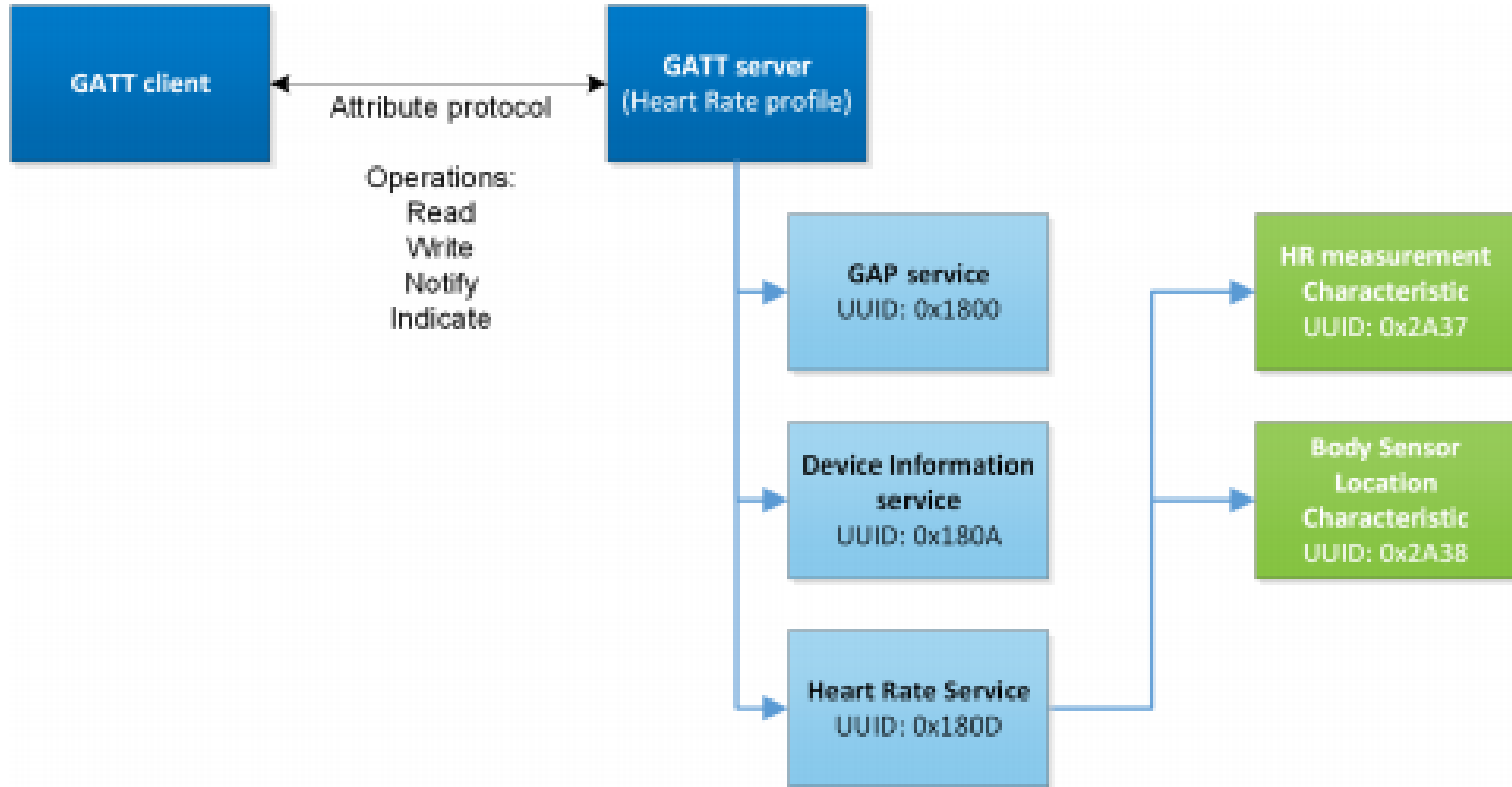

Attribute server keywords

- Characteristic
 - A field with properties and a value
 - Descriptor: metadata about the characteristic
- Service
 - Collection of characteristics
- Profile
 - Collection of services

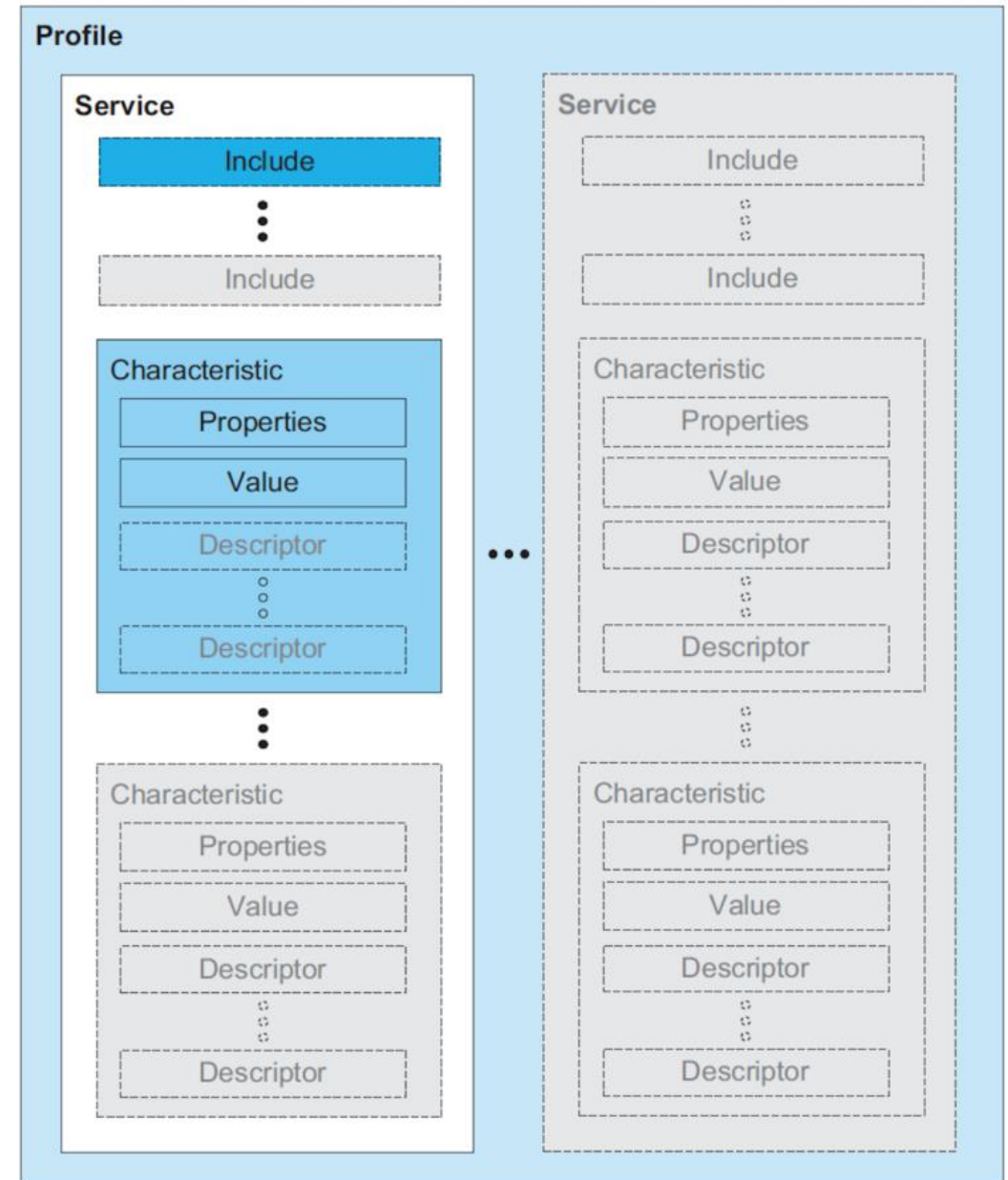

Example: Time Profile

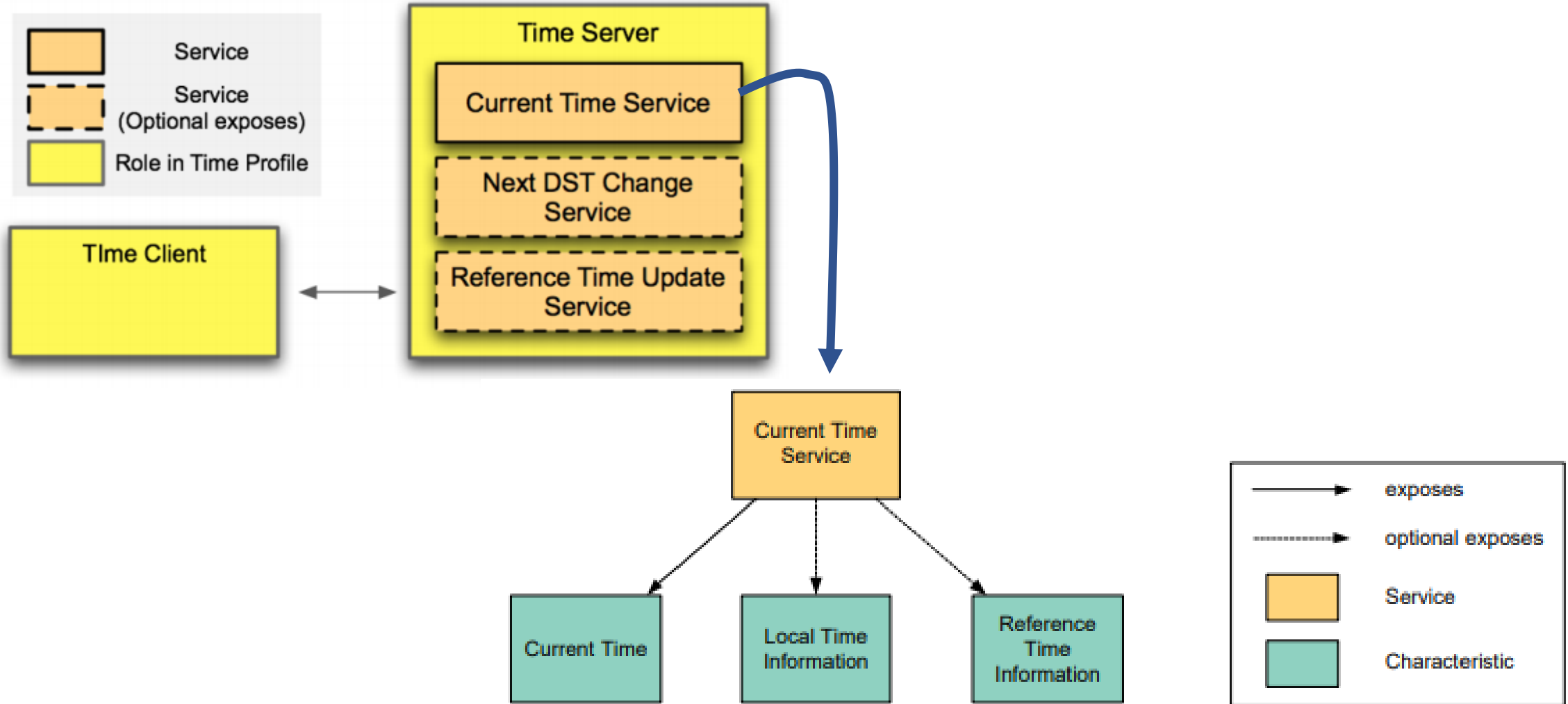

Current time characteristic

Field	Data Type	Size (in octets)	Description
Exact Time 256	struct	9	Refer to the Exact Time 256 characteristic in Section 3.64
Adjust Reason	uint8	1	See Section 3.58.2.1

Bit	Bit Name
0	Manual Time Update
1	External Reference Time Update
2	Change of Time Zone
3	Change of DST
4-7	Reserved for Future Use

Field	Data Type	Size (in octets)	Description
Day Date Time	struct	8	Refer to the Day Date Time characteristic in Section 3.54.
Fractions256	uint8	1	The number of 1/256 fractions of a second. Valid range 0-255.

Field	Data Type	Size (in octets)	Description
Date Time	struct	7	Refer to the Date Time characteristic in Section 3.53
Day of Week	struct	1	Refer to the Day of Week characteristic in Section 3.55

Field	Data Type	Size (in octets)	Description
Year	uint16	2	Year as defined by the Gregorian calendar. Valid range 1582 to 9999. A value of 0 means that the year is not known. All other values are reserved for future use (RFU).
Month	uint8	1	Month of the year as defined by the Gregorian calendar. Valid range 1 (January)

The Bluetooth SIG are just terrible, pedantic people

Documentation of GATT standards

- <https://www.bluetooth.com/specifications/gatt/>
 - Various profiles and services that have been standardized
- [GATT Specification Supplement](#)
 - Various characteristic definitions that have been standardized
- Both incredibly specific and woefully inexhaustive

UUIDs and handles

- Universally Unique Identifiers

- 128-bit, mostly random with a few bits for versioning
- Example: 00000000-0000-1000-8000-00805F9B34FB
 - This is the default BLE UUID for *known* services
 - You can generate your own UUID for custom services

- Handles

- Too long to pass around all the time, so pick 16 bits that mean that UUID
 - Must be unique among services/characteristics on that device
- Taken from UUID: 0000**xxxx**-0000-1000-8000-00805F9B34FB
- Handle often sequentially incremented for each new characteristic within a service

Discovery

- When a connection first occurs, each device can query the other for a list of services
 - And can further query for a list of characteristics in that service
 - Gets a list of handles/UUIDs
- Standardized UUIDs can be interpreted immediately
 - Custom services/characteristics need documentation from the manufacturer

Interacting with characteristics

- Depends on their permissions
 - Readable, Writable, Notify-able, etc.
- Notify
 - Automatically get a message sent whenever the characteristic value updates
 - Note: have to enable this on both sides, it's not the default behavior
- Long characteristics are automatically fragmented across multiple packets and/or connection events
 - L2CAP is in charge of this

Outline

- Connection Link Layer
- Connection Investigations
- GATT

- **BLE 5**

Changes in BLE 5

- Major changes
 - Multiple physical layers (optional implementation 😞)
 - Advertising extensions
 - Localization extensions (will discuss later with localization)
- Minor changes
 - Various quality of life improvements
 - Examples:
 - Advertise on channels in any order
 - Better data channel hopping algorithm

Revised physical layers

- 2 Mbps PHY
 - Transmit data faster
 - Transmit more data in the same time
- Coded PHY
 - Forward Error Correction in the data stream
 - 1 bit -> 2 symbols or 8 symbols
 - Makes bits more reliable -> longer distance
 - 500 kbps and 125 kbps modes
- Connections can switch to these PHYs after creation
- Advertisements can use these with extensions only

Coded PHY mixes physical and link layers

- Different PHY settings at different times
 - Make beginning headers extra-reliable
 - Data might be slightly less reliable as a trade for faster speed

Packet sent with coded PHY

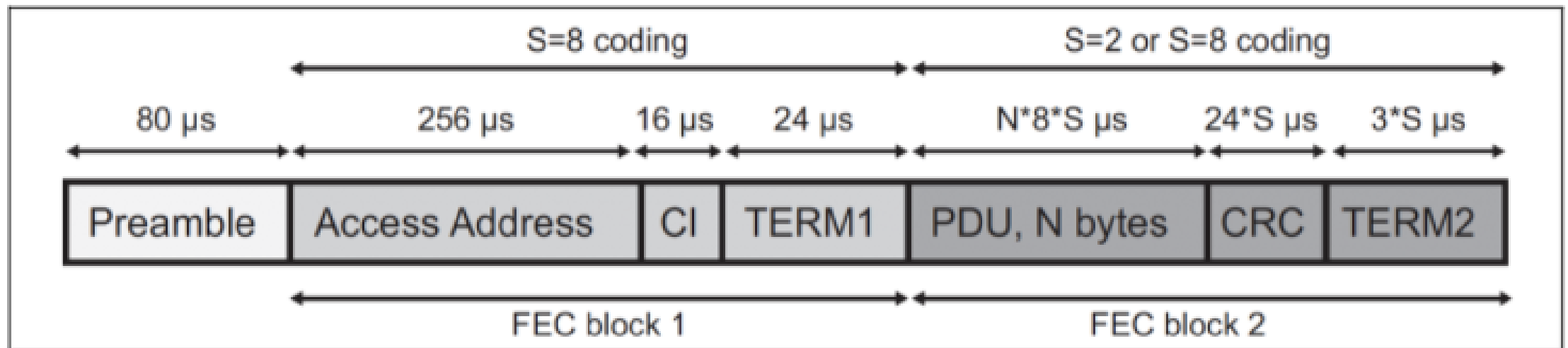

Revised processing path

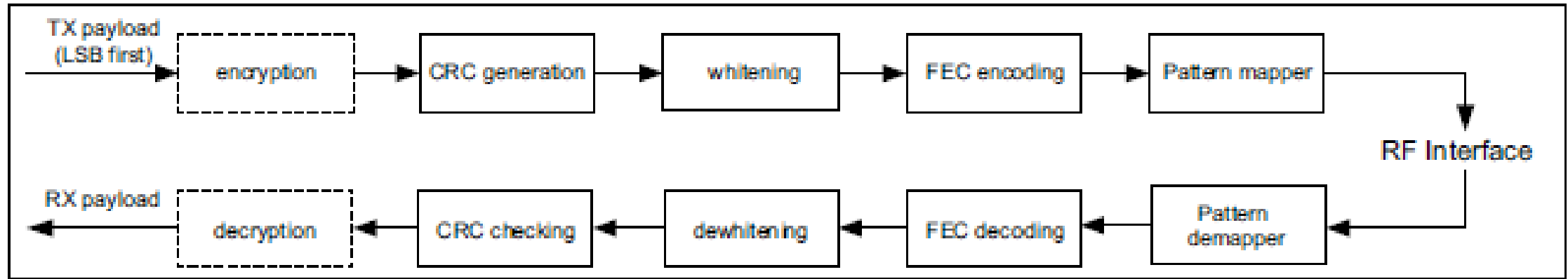
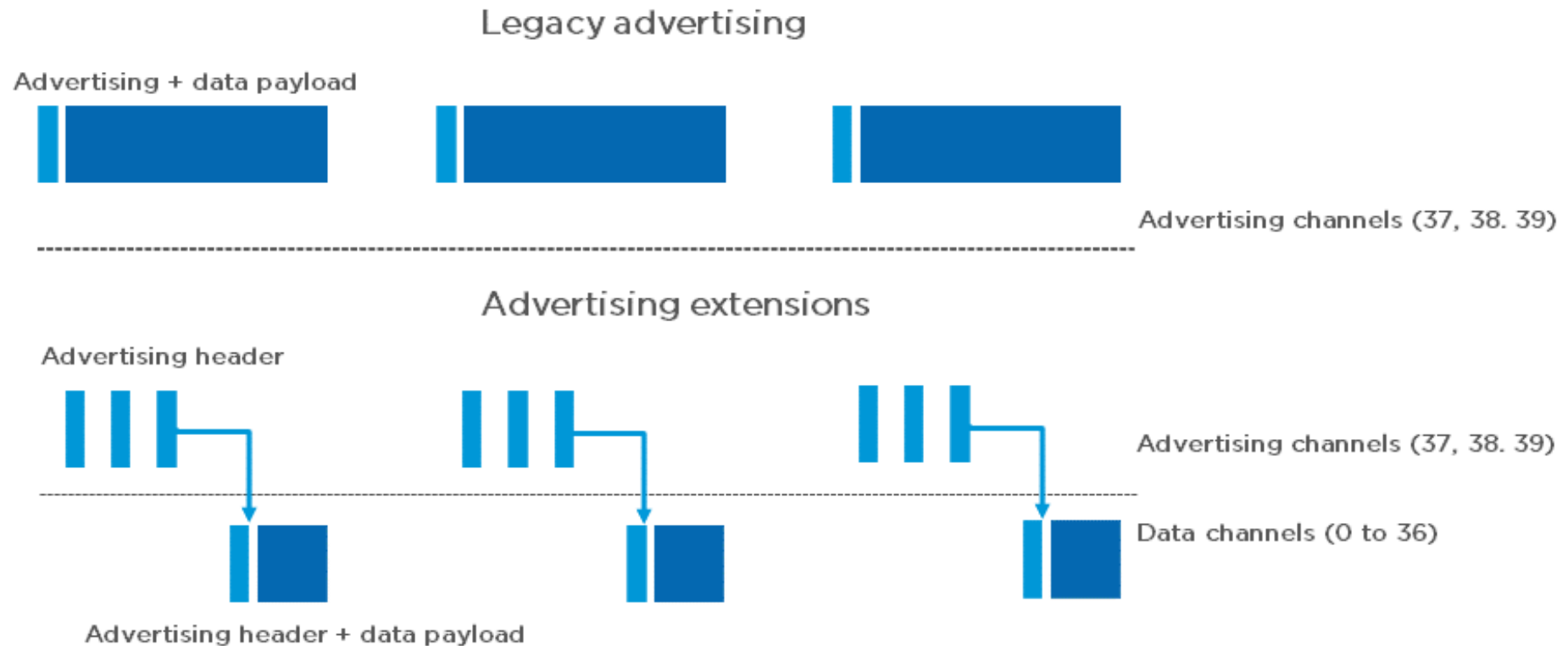

Figure 3.2: Bit stream processing for the LE Coded PHYs

Extended advertising

- Allow bigger payloads and/or different PHYs
 - Uses Data Channels to do so. **Why?**
 - Regular advertisements point to extended advertisements



Extended advertising

- Allow bigger payloads and/or different PHYs
 - Uses Data Channels to do so. **Why? Packet collisions!**
 - Regular advertisements point to extended advertisements

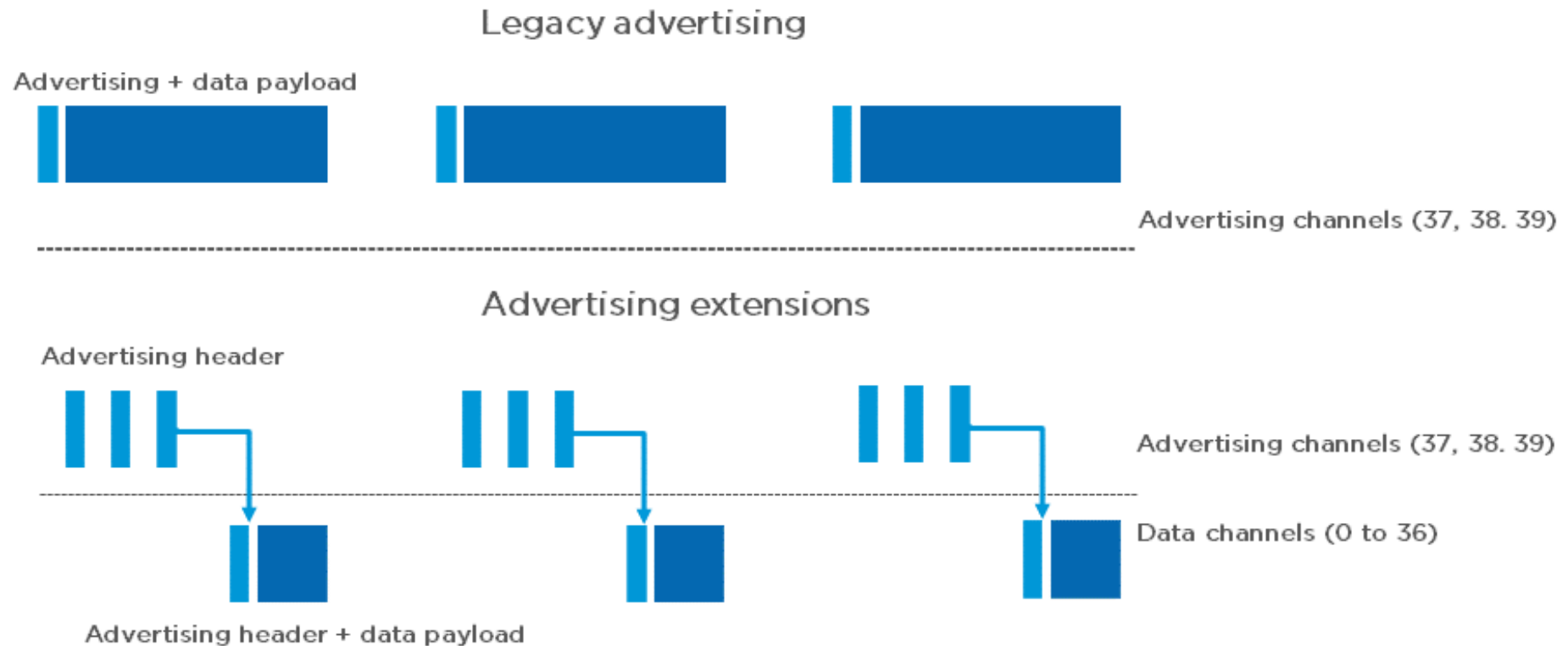

Procedure for scanning extended advertisements

1. Scan on 3 primary channels for advertising packets.
2. If ADV_EXT_IND is scanned, record the secondary channel information (which channel and when etc.)
3. Scan the specific secondary channel at the given time.

Extended advertisement train on data channels

Bluetooth 5 Advert Extensions - Overview



3 Advertisement Channels

37 Data Channels

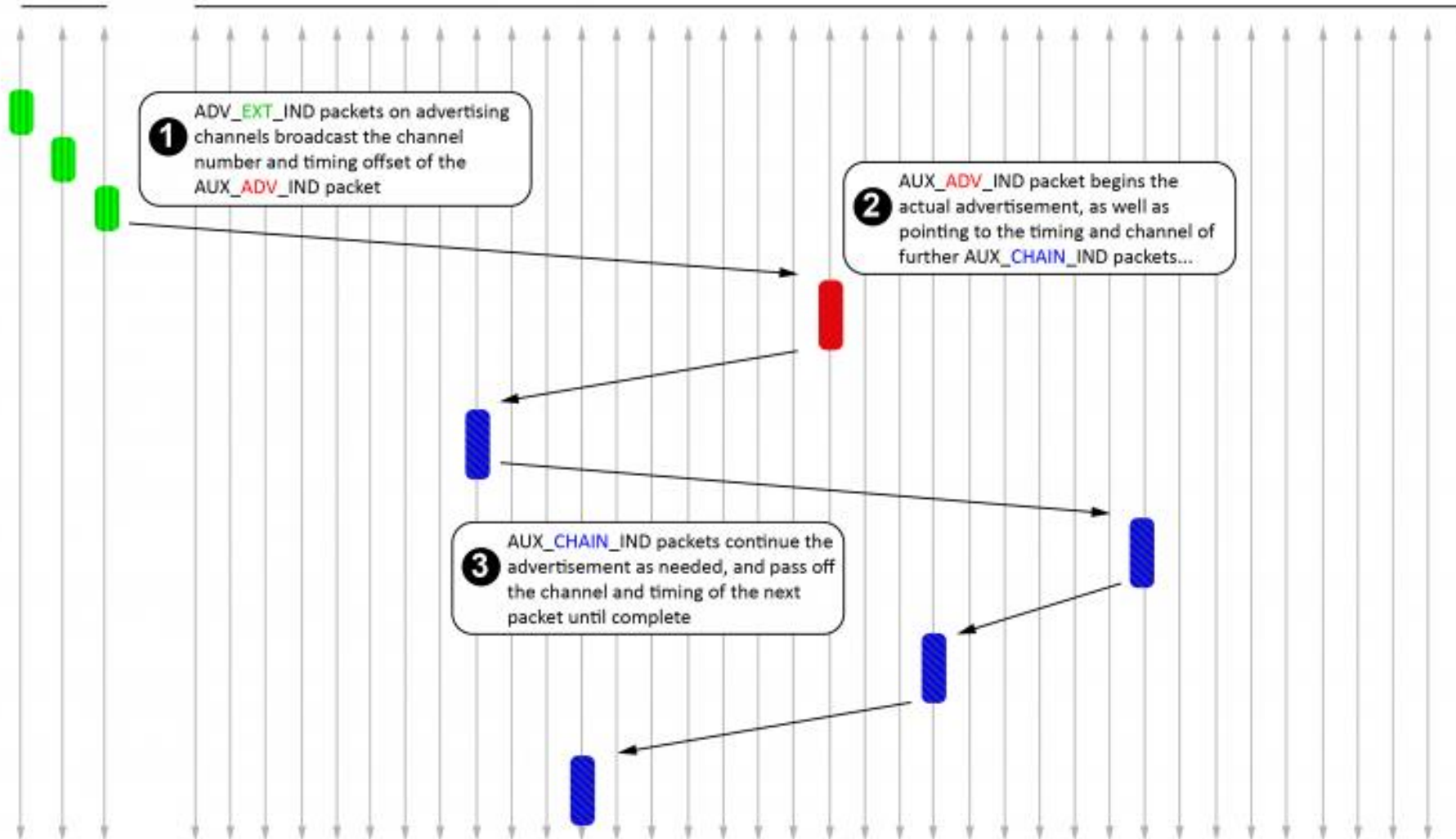

Use case:
long advertisements
that need to be
fragmented

Periodic advertising on data channels

Bluetooth 5 Advert Extensions - Sync Packets (e.g. Compressed Audio)



3 Advertisement Channels

37 Data Channels

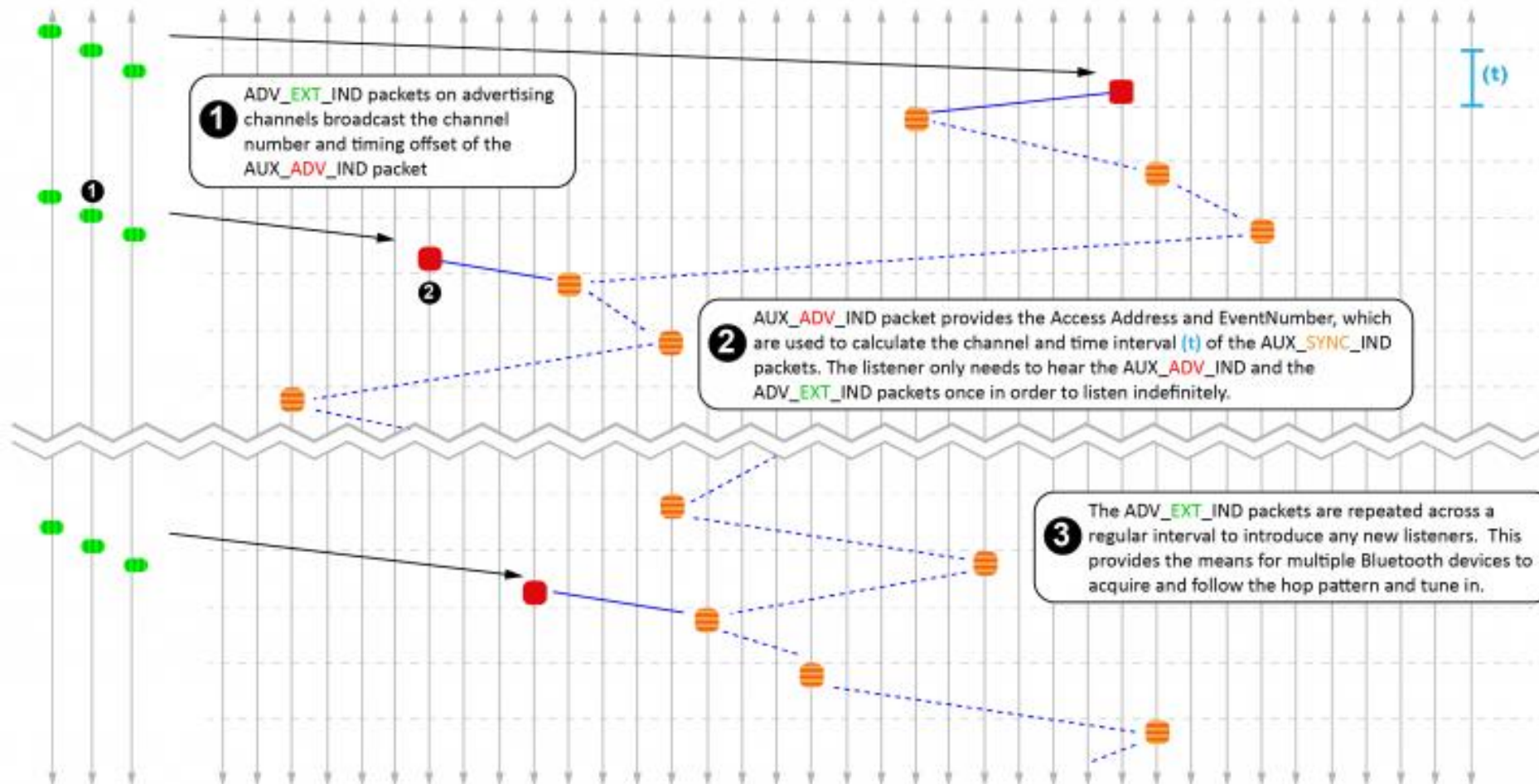

Use case:
publicly-available
localized audio
sources

- TV in a bar
- Commentary in a museum

Broadcast analogy
of a connection

Downside:
how many of these
can a gateway
follow at a time?

Outline

- Connection Link Layer
- Connection Investigations
- GATT

- BLE 5