

# Lecture 10

## WiFi PHY

CS397/497 – Wireless Protocols for IoT  
Branden Ghena – Spring 2024

Materials in collaboration with  
Pat Pannuto (UCSD) and Brad Campbell (UVA)

# Administrivia

- Hw: Matter
  - Due Thursday
- Lab: Thread
  - Due next week Wednesday
- Lab: WiFi
  - Less time than the other labs to complete it
  - Releases later this week. I have some hardware today
- Recent Piazza posts
  - Articles on Matter (state of Matter 2023)
  - Home Assistant – open-source home automation system

# Today's Goals

- Discuss WiFi physical layers
  - Get a feel for what choices are leading to more throughput
  - Think a little about what the costs of that are
- Explore how WiFi has continuously improved over 30 years

# Outline

- **WiFi Overview**
- WiFi PHY
  - 802.11/802.11b
  - 802.11a/802.11g
  - 802.11n/802.11ac
  - 802.11ax
- Real-World WiFi

# What is WiFi?

- Most successful wireless protocol (family)
- Small Area (~35m), high performance (up to 9,600 Mbit/s)
- ~30 years young
  - We'll do some history
  - Note the parallels in technology development
    - First: Maximize the performance of a single channel
    - Now: Improve performance through parallelism (more channels working together)



# 802.11 timeline

- 1985 – US FCC rules ISM band for unlicensed use
- 1990s – WaveLAN (NCR Corporation, Netherlands)
  - Wireless ethernet for cashier systems
- 1997 – 802.11 specification
- 1999 – 802.11b and 802.11a amendments
- 1999 – WiFi Alliance formed for certification of devices
- 1999 – Apple iBook is the first consumer WiFi product



# Major amendments

	<b>Protocol</b>	<b>Year</b>	<b>Frequency</b>	<b>PHY</b>	<b>Max Rate</b>	<b>Range</b>
-	802.11	1997	2.4 GHz	DSSS/FHSS	2 Mbps	20 m
1	802.11b	1999	2.4 GHz	DSSS	11 Mbps	35 m
2	802.11a	1999	5 GHz	OFDM	54 Mbps	35 m
3	802.11g	2003	2.4 GHz	OFDM	54 Mbps	38 m
4	802.11n	2009	2.4/5 GHz	OFDM + MIMO	600 Mbps	70 m
5	802.11ac	2013	5 GHz	OFDM + MU-MIMO (downlink only)	3.4 Gbps	35 m
6	802.11ax	2021	2.4/5/[6] GHz	OFDMA + MU-MIMO	9.6 Gbps	35 m
7	802.11be	TBA	2.4/5/6 GHz	OFDMA + MU-MIMO	40 Gbps	35 m

- 802.11b was very popular but is now usually unsupported
- 802.11a never saw major deployment
- WiFi Alliance rebranded 802.11ac as “WiFi 5” and backported scheme

# Resources

- Peter Steenkiste – Carnegie Mellon University
  - <https://www.cs.cmu.edu/~prs/wirelessS18/handouts/L11-AdHoc.pdf>
  - <https://www.cs.cmu.edu/~prs/wirelessS18/handouts/L12-LAN.pdf>
- Raj Jain – Washington University in Saint Louis
  - [https://www.cse.wustl.edu/~jain/cse574-14/ftp/j\\_05lan.pdf](https://www.cse.wustl.edu/~jain/cse574-14/ftp/j_05lan.pdf)
  - [https://www.cse.wustl.edu/~jain/cse574-14/ftp/j\\_06lan.pdf](https://www.cse.wustl.edu/~jain/cse574-14/ftp/j_06lan.pdf)
- Honestly
  - [https://en.wikipedia.org/wiki/IEEE\\_802.11](https://en.wikipedia.org/wiki/IEEE_802.11)



# Outline

- **WiFi Overview**
- **WiFi PHY**
  - 802.11/802.11b
  - 802.11a/802.11g
  - 802.11n/802.11ac
  - 802.11ax
- Real-World WiFi

# WiFi Physical Layer

- Details start to get pretty messy here for multiple reasons:
  1. Different countries/regions have different standards
    - Channels look a little different in different areas
  2. WiFi has evolved over the last 30 years
    - Different features are designed for different amendments
  3. WiFi is focused on improving throughput
    - Solutions that were initially “too complicated” no longer are

# Goal: improve throughput

- In twenty years, WiFi has gone from 2 Mbps to 9.6 Gbps
- **How does a network PHY improve its throughput?**

# Goal: improve throughput

- In twenty years, WiFi has gone from 2 Mbps to 9.6 Gbps
  - **How does a network PHY improve its throughput?**
1. More capable modulation and/or bit transmission
    - Techniques like OFDM and MIMO
  2. More bandwidth
    - Increased channel with at 2.4 Ghz and bigger 5 GHz channels

# Walking through PHY changes by amendment

	Protocol	Year	Frequency	PHY	Max Rate	Range
-	<b>802.11</b>	1997	2.4 GHz	DSSS/FHSS	2 Mbps	20 m
1	<b>802.11b</b>	1999	2.4 GHz	DSSS	11 Mbps	35 m
2	802.11a	1999	5 GHz	OFDM	54 Mbps	35 m
3	802.11g	2003	2.4 GHz	OFDM	54 Mbps	38 m
4	802.11n	2009	2.4/5 GHz	OFDM + MIMO	600 Mbps	70 m
5	802.11ac	2013	5 GHz	OFDM + MU-MIMO	3.4 Gbps	35 m
6	802.11ax	2021	2.5/5/[6] GHz	OFDMA + MU-MIMO	9.6 Gbps	35 m
7	802.11be	TBA	2.5/5/6 GHz	OFDMA + MU-MIMO	40 Gbps	35 m

# Original WiFi specification (1997)

- Legacy WiFi
  - Frequency Hopping Spread Spectrum (FHSS)
  - GFSK (Gaussian Frequency-Shift Keying)
    - Relatively simple radio design
  - Frequency hopping over 80 channels (1 MHz each)
  - Actually supports an Infrared PHY as well!!

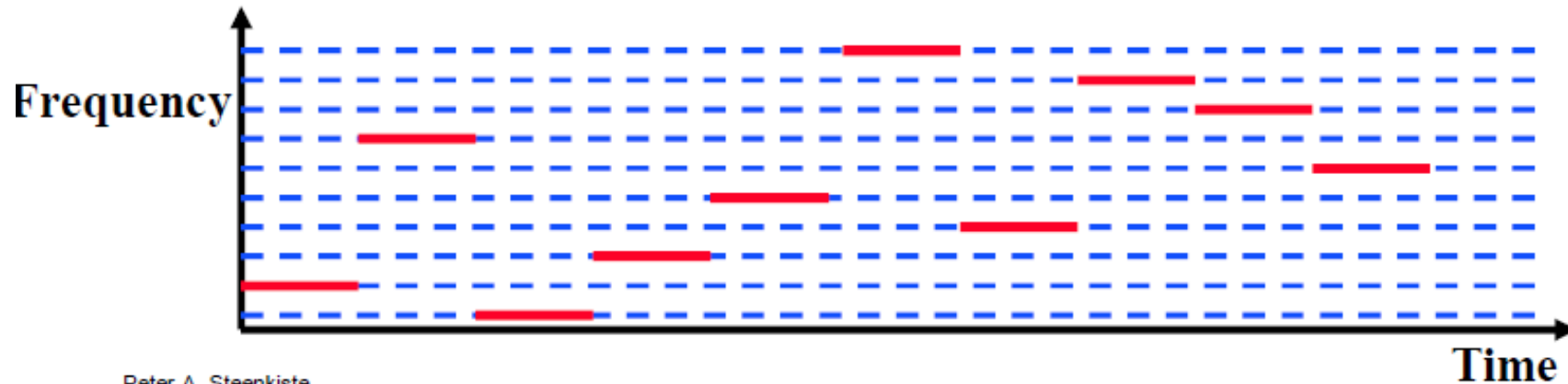

Peter A. Steenkiste

# 802.11b (1999)

- 802.11b

- Direct Sequence Spread Spectrum (DSSS)
- DBPSK and DQPSK (Differential Binary/Quadrature Phase-Shift Keying)

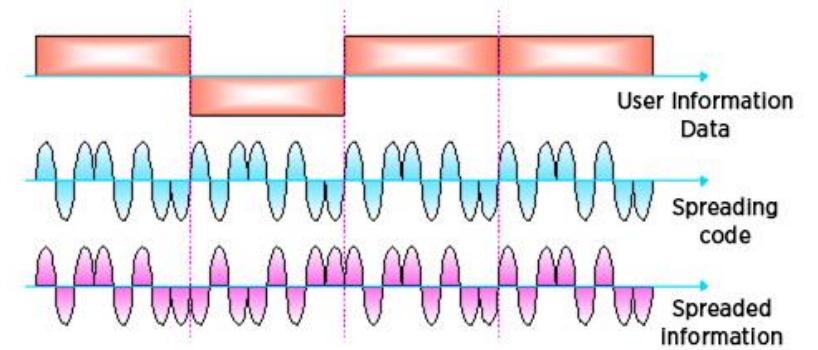

- Translate data into "codes"

- Each data bit corresponds to several code bits (Chips)
- Chips are what is actually modulated over the air
- Data can be recovered by knowing the code patterns

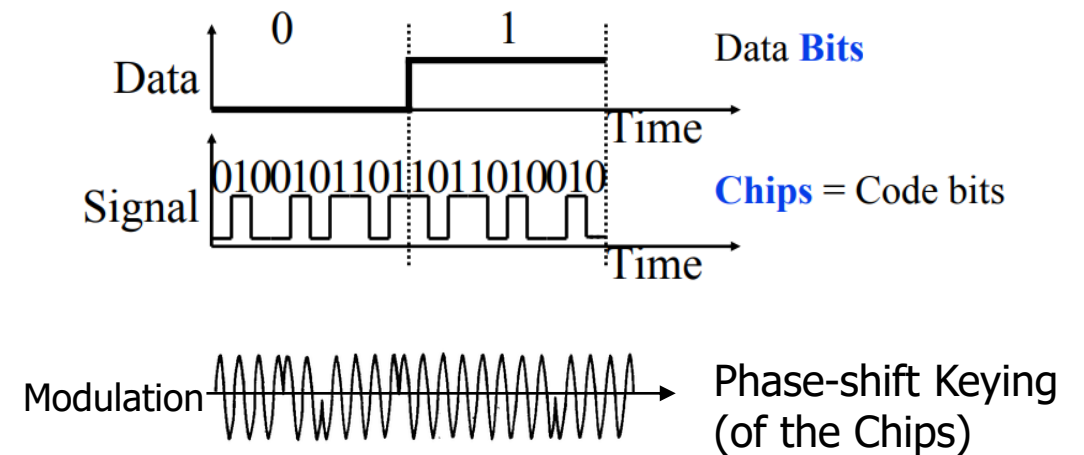





# DSSS goals

- DSSS increases bandwidth of a signal
  - Beyond what is needed for the data
  - Energy is smeared across the frequencies
- More robust against interference
  - Narrowband signals knock out only part of the signal
  - Data can be recovered from partial code
- Cost: using a lot of bandwidth for only a little data

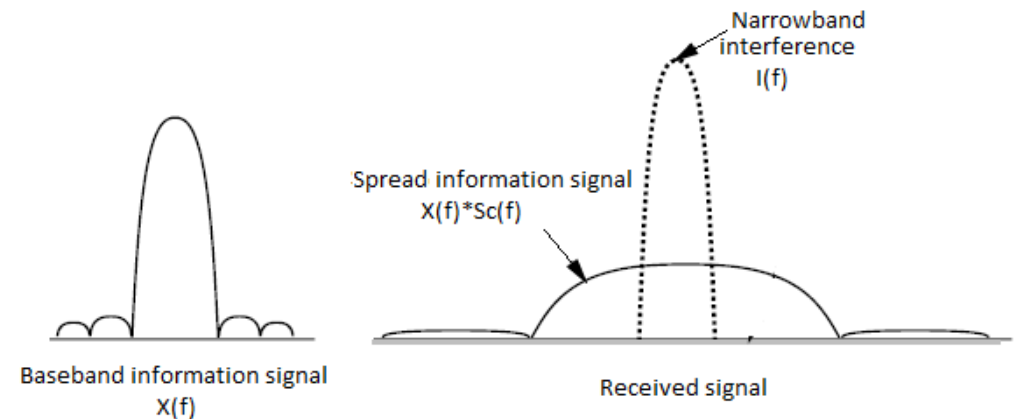
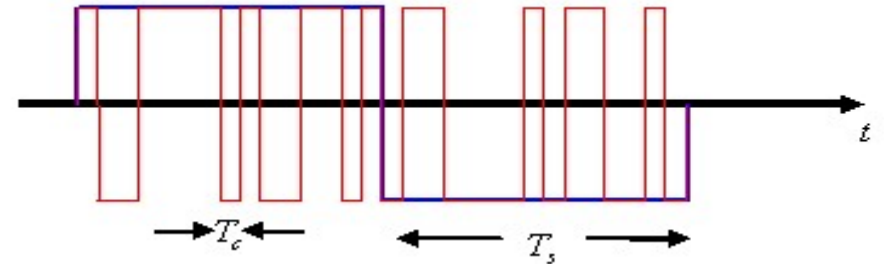

# 802.11b channels

- 14 channels total
  - 1-11 for US
  - 1-13 for most of the rest of the world
  - 1-14 for Japan (but 14 only for 802.11b)
- 22 MHz channels
  - 5 MHz spacing -> significant channel overlap
  - Channels 1, 6, and 11 can be used without overlap

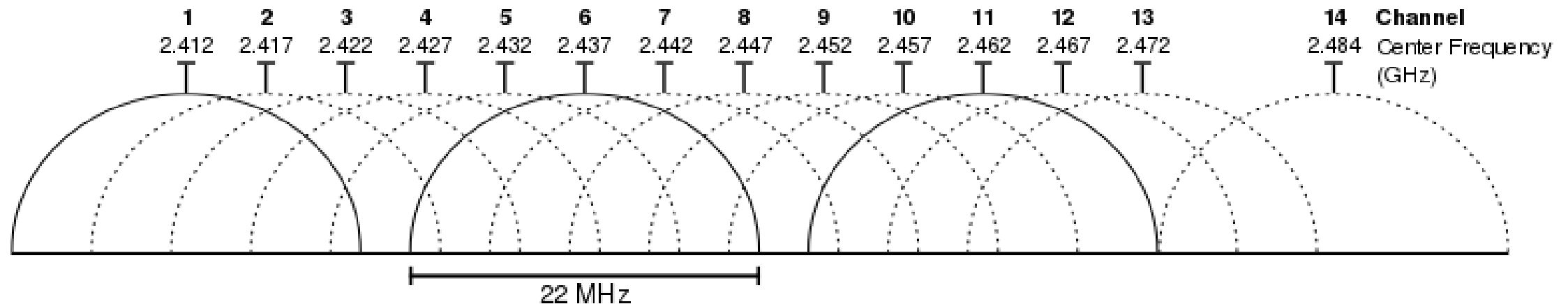

# Break + Question

- If the majority of channels overlap, why even have them?

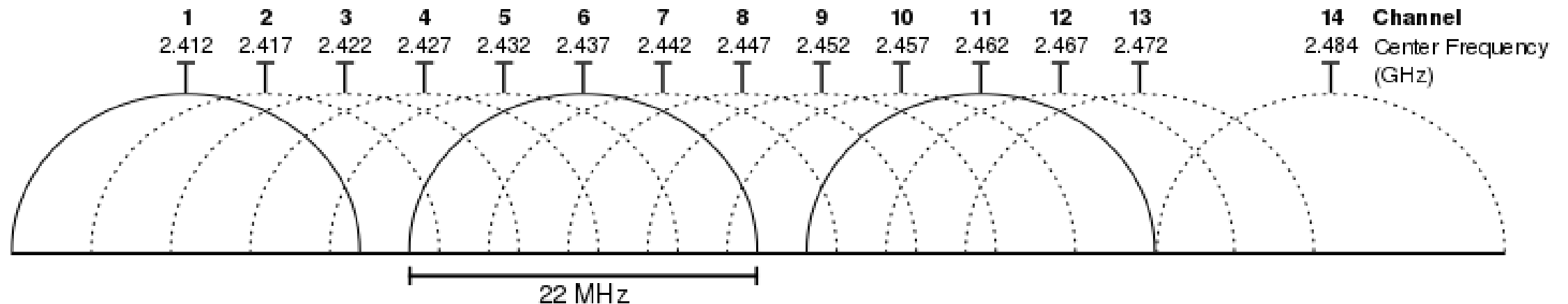

# Break + Question

- If the majority of channels overlap, why even have them?
  - Different options for different regions
  - Inside US use three channels: 1, 6, 11
  - Outside of North America can use four channels: 1, 5, 9, 13
- Historical: avoid other 2.4 GHz users
  - If they're at the low end of the band, you could switch to channel 2 or 3

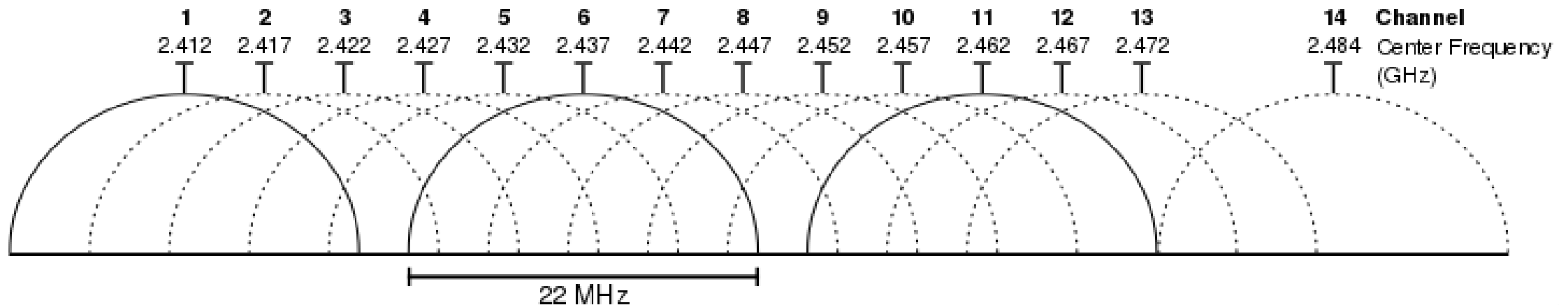

# Walking through PHY changes by amendment

	Protocol	Year	Frequency	PHY	Max Rate	Range
-	802.11	1997	2.4 GHz	DSSS/FHSS	2 Mbps	20 m
1	802.11b	1999	2.4 GHz	DSSS	11 Mbps	35 m
2	<b>802.11a</b>	1999	5 GHz	OFDM	54 Mbps	35 m
3	802.11g	2003	2.4 GHz	OFDM	54 Mbps	38 m
4	802.11n	2009	2.4/5 GHz	OFDM + MIMO	600 Mbps	70 m
5	802.11ac	2013	5 GHz	OFDM + MU-MIMO	3.4 Gbps	35 m
6	802.11ax	2021	2.5/5/[6] GHz	OFDMA + MU-MIMO	9.6 Gbps	35 m
7	802.11be	TBA	2.5/5/6 GHz	OFDMA + MU-MIMO	40 Gbps	35 m

# OFDM enables higher throughput

- Replace DSSS with Orthogonal Frequency Division Multiplexing

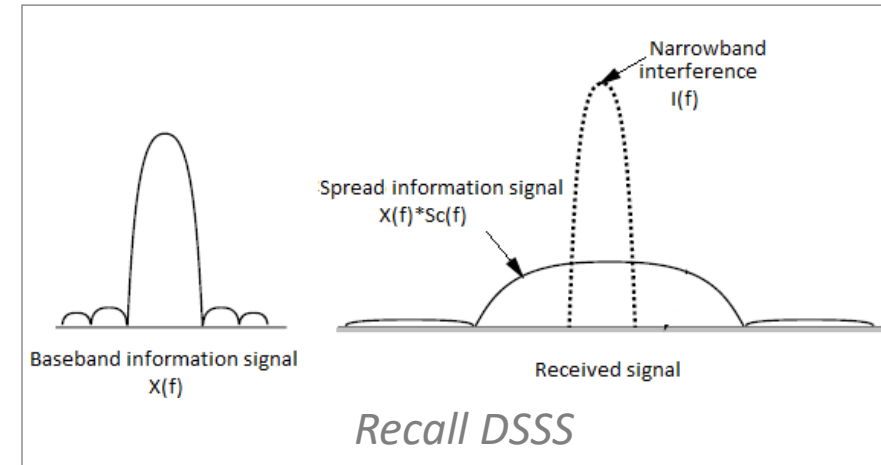

- OFDM idea

- Split band into a number of narrow subcarriers
- Subcarriers are spaced so that they don't interfere
- Transmit on multiple subcarriers at once to increase throughput

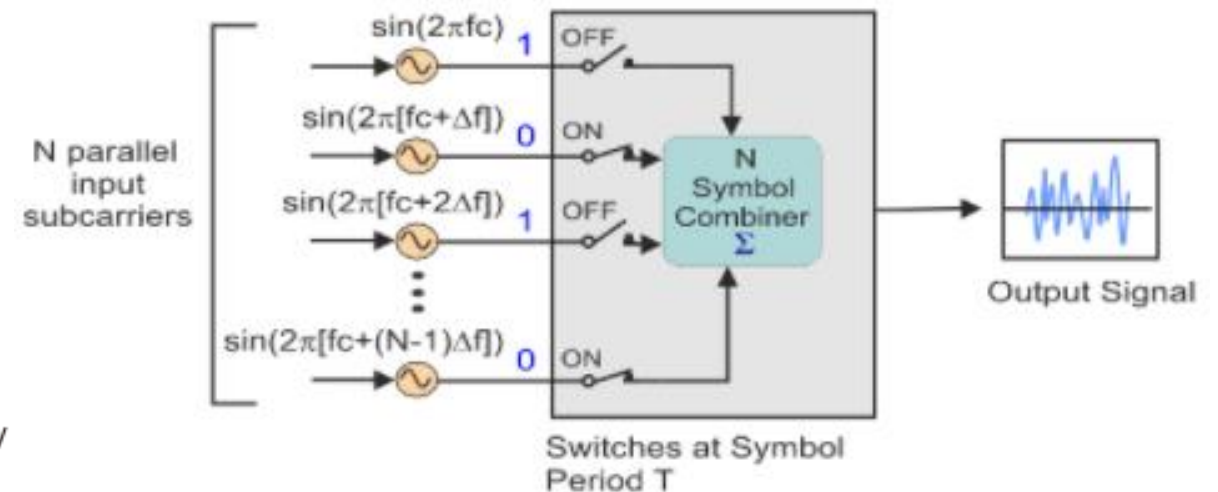
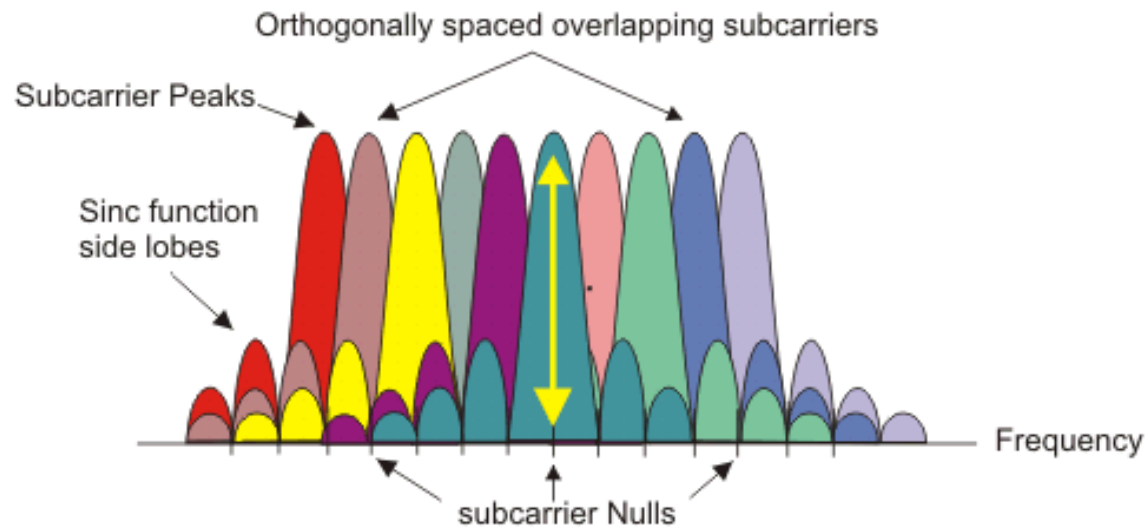

# OFDM enables higher throughput at complexity cost

- Receivers collect signal from entire channel
  - And then can split it apart to gain the data on each subcarrier

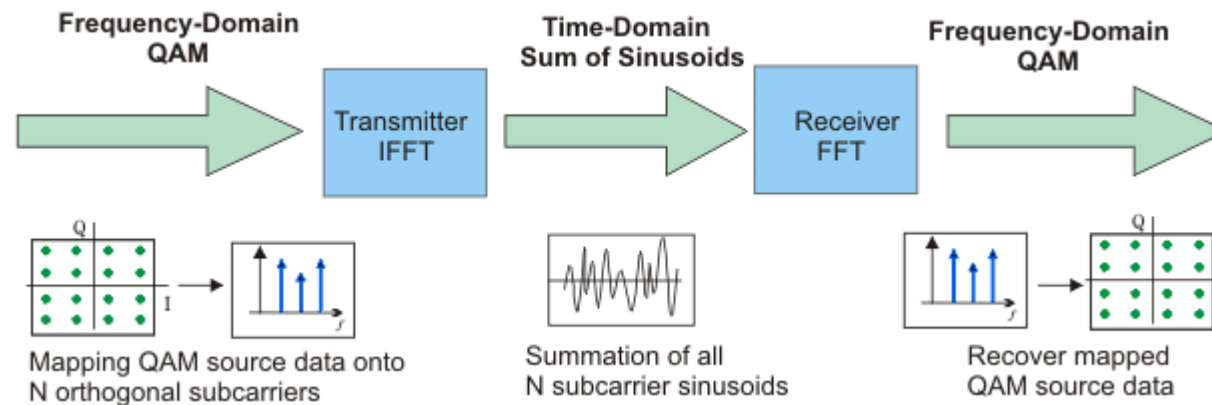

- Tradeoffs
  - Benefits: more throughput, still robust against narrowband interference
  - Costs: more complicated and sensitive radio design

# 802.11a (1999)

- Applied OFDM techniques on the 5 GHz band
  - Enabled more data throughput 54 Mbps (compare to 11 Mbps for 802.11b)
- Multiple rates available
  - BPSK/QPSK/QAM over OFDM
  - Quadrature Amplitude Modulation (QAM)
- Never reached widespread adoption
  - Regulatory hurdles in some regions
  - More complicated hardware delayed it

RATE bits	Modulation type	Coding rate	Data rate (Mbit/s) <sup>[a]</sup>
1101	BPSK	1/2	6
1111	BPSK	3/4	9
0101	QPSK	1/2	12
0111	QPSK	3/4	18
1001	16-QAM	1/2	24
1011	16-QAM	3/4	36
0001	64-QAM	2/3	48
0011	64-QAM	3/4	54



# 802.11a channels

- 802.11a did promote the use of 5 GHz band
  - Several 20 MHz channels with no overlap (9ish in the US)
    - Big increase from “three” channels of 2.4 GHz
- Various regional rules on a number of different channels
  - Needs to avoid frequencies in use by existing radar deployments
  - Orange channels aren't usually used in the US at least

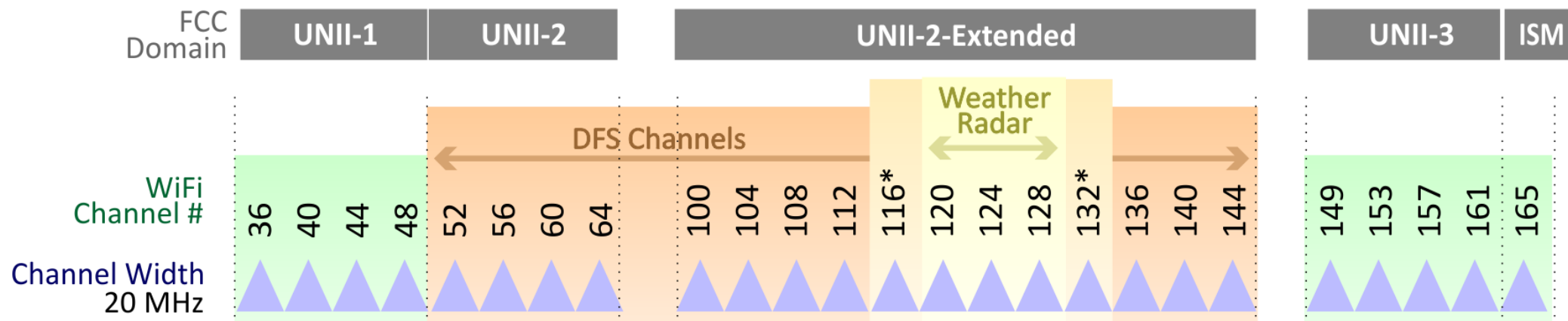

# Walking through PHY changes by amendment

	Protocol	Year	Frequency	PHY	Max Rate	Range
-	802.11	1997	2.4 GHz	DSSS/FHSS	2 Mbps	20 m
1	802.11b	1999	2.4 GHz	DSSS	11 Mbps	35 m
2	802.11a	1999	5 GHz	OFDM	54 Mbps	35 m
3	<b>802.11g</b>	2003	2.4 GHz	OFDM	54 Mbps	38 m
4	802.11n	2009	2.4/5 GHz	OFDM + MIMO	600 Mbps	70 m
5	802.11ac	2013	5 GHz	OFDM + MU-MIMO	3.4 Gbps	35 m
6	802.11ax	2021	2.5/5/[6] GHz	OFDMA + MU-MIMO	9.6 Gbps	35 m
7	802.11be	TBA	2.5/5/6 GHz	OFDMA + MU-MIMO	40 Gbps	35 m

# 802.11g (2003)

- Applies OFDM to 2.4 GHz band
  - Increases throughput from 11 Mbps to 54 Mbps
  - Repeats rate choices of 802.11a but on more support 2.4 GHz band
- Same 2.4 GHz channels as 802.11b, but 20 MHz bandwidth
  - Still 1, 6, 11 in US
  - 1, 5, 9, 13 in other regions
- Backwards compatible with 802.11b
  - Capable of DSSS communication when required

# Cost of supporting 802.11b

- 802.11g uses a completely different PHY layer than 802.11b
  - DSSS -> OFDM
  - Unintelligible to old receivers creating an interoperability problem
- Interoperability mode: send part of message in old format
  - DSSS header with OFDM payload
  - Adds overhead and slows down the entire network
    - Starting with 802.11n, routers don't support 802.11b by default

Allow legacy 802.11b rates

## Truth or Fiction:

“An 802.11b device slows your whole network to b speed”

- Aka, should you have followed all the blogs telling you to do this?:

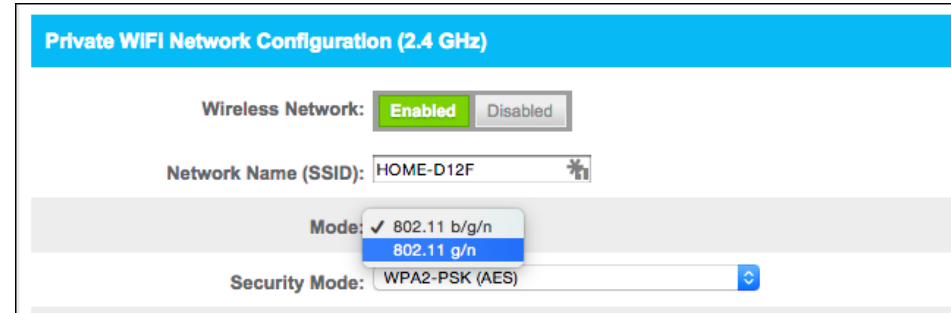

- A: “Sort of”, and “no”
  - When *active*, **b** devices slow networks simply because they occupy the channel
  - Cutting off your **b** devices doesn't cut off your neighbor's
    - *Contention* [without coordination] is the bigger problem
  - On own network, routers are “**b**-aware”, and can schedule around efficiently
    - At cost of “talking **b**” to everyone a little

# Improved WiFi hardware is in high demand

- Typically, standards lead hardware by several years
  - BLE 5.2 was out, while 5.0 was just being adopted in phones
- Development of 802.11g hardware started *before* finalization of standard
  - Demand for increased performance was already high in 2003
- Phenomena continues in modern WiFi and Cellular protocols
  - Hardware supports some features as soon as it's clear they'll exist

# Walking through PHY changes by amendment

	Protocol	Year	Frequency	PHY	Max Rate	Range
-	802.11	1997	2.4 GHz	DSSS/FHSS	2 Mbps	20 m
1	802.11b	1999	2.4 GHz	DSSS	11 Mbps	35 m
2	802.11a	1999	5 GHz	OFDM	54 Mbps	35 m
3	802.11g	2003	2.4 GHz	OFDM	54 Mbps	38 m
4	<b>802.11n</b>	2009	2.4/5 GHz	OFDM + MIMO	600 Mbps	70 m
5	802.11ac	2013	5 GHz	OFDM + MU-MIMO	3.4 Gbps	35 m
6	802.11ax	2021	2.5/5/[6] GHz	OFDMA + MU-MIMO	9.6 Gbps	35 m
7	802.11be	TBA	2.5/5/6 GHz	OFDMA + MU-MIMO	40 Gbps	35 m

# How do we increase throughput?

- Wired world
  - Add more wires in parallel

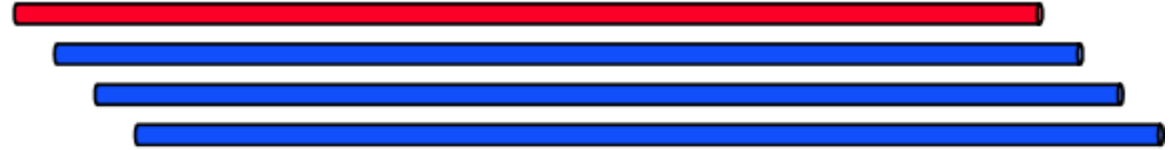

- Wireless world
  - Add more antennas?

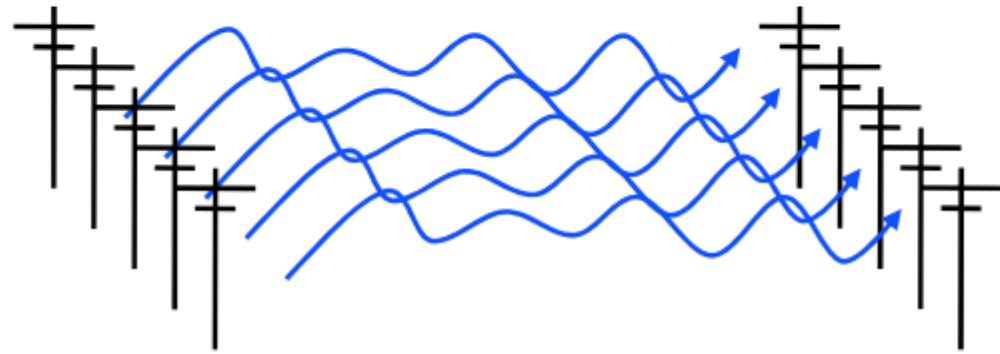



# How do we increase throughput?

- Water world
  - Fatter pipes
- Wireless world
  - Fatter channels  
(with more bandwidth)

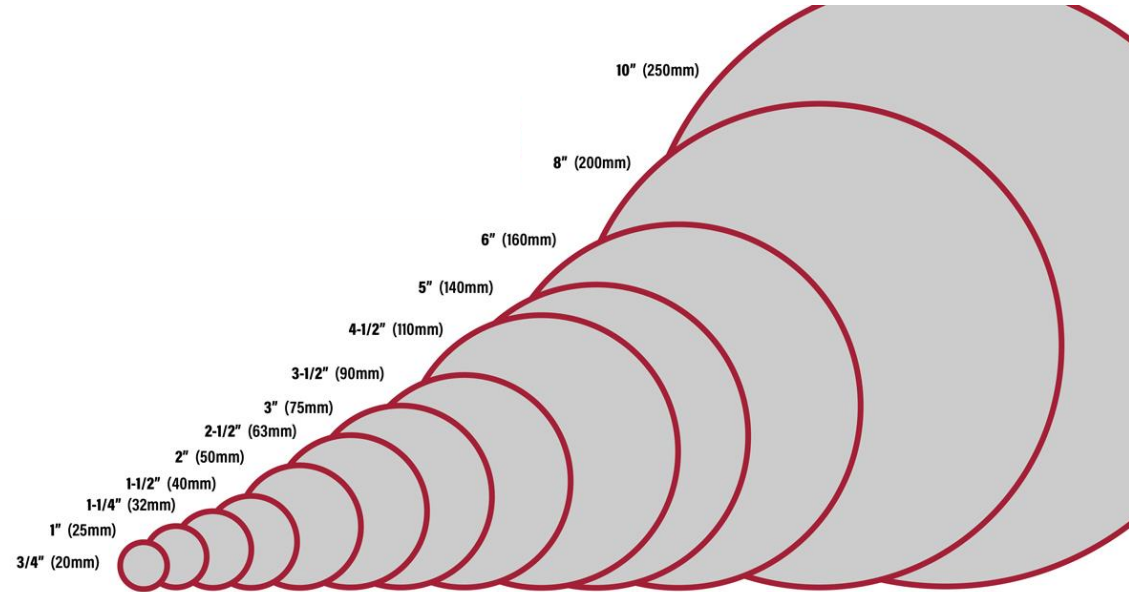

***802.11.n — Y NOT BOTH?***

# MIMO – Multiple In Multiple Out

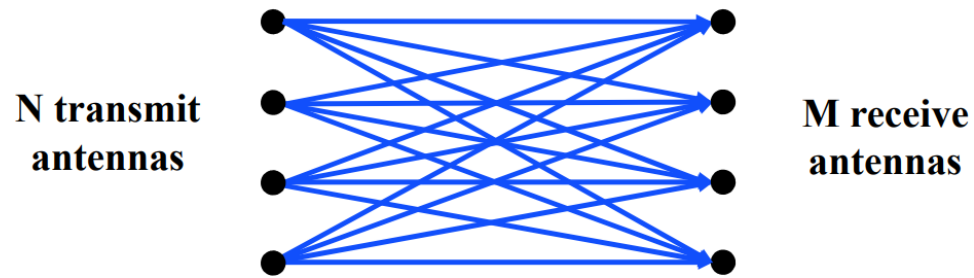

- N x M subchannels can be used to send data simultaneously
  - Huge boost in data throughput
  - Antenna diversity adds to reliability as well
- The signals may interfere with each other
  - But receiving all of them allows the data to be recovered
- Beamforming
  - Use interactions between array of antennas to focus energy on the receiver
  - Way outside of the scope of this class

# Expandable bandwidth

- OFDM allows many subcarriers within a channel to be used at once
  - Throughput scales with the amount of bandwidth available
  - Allow larger 40 MHz channels to be used

**802.11g/n (OFDM) 20 MHz ch. width - 16.25 MHz used by sub-carriers**

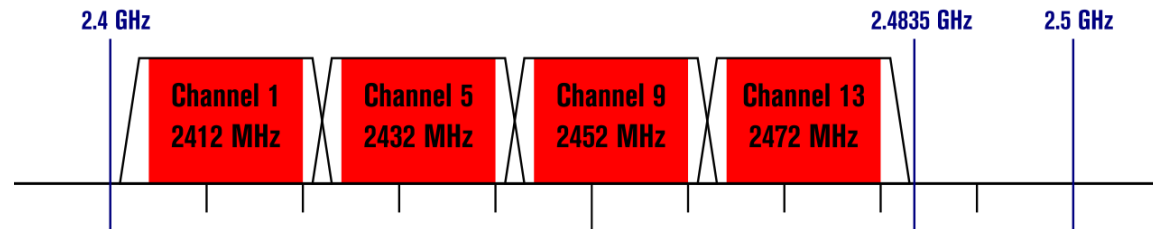

**802.11n (OFDM) 40 MHz ch. width - 33.75 MHz used by sub-carriers**

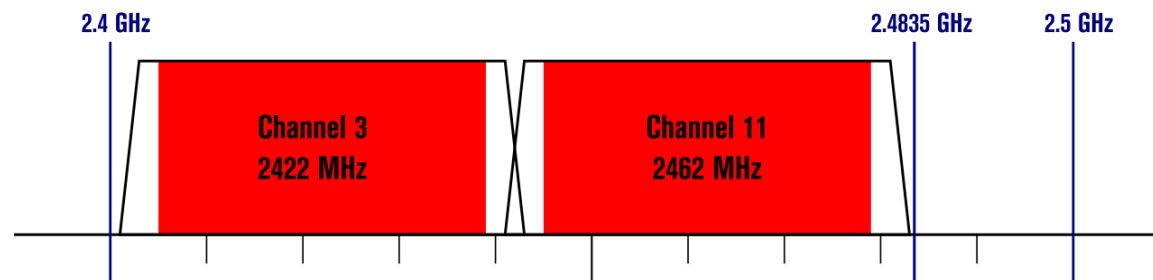

# 802.11n (2009)

- Supports OFDM and MIMO on 2.4 GHz and 5 GHz
- Supports 20 MHz and 40 MHz channels
  - Easier to create large channels in 5 GHz band
- Backwards compatible with 802.11g (tries not to be with 802.11b)
- Wildly successful
  - Still the 2.4 GHz band protocol (802.11ac is 5 GHz only)
  - A little less than half of the networks visible to me are still 802.11n
  - My apartment “building WiFi” was still 802.11g...

# 802.11n modulation and coding schemes

Modulation and coding schemes

MCS index	Spatial streams	Modulation type	Coding rate	Data rate (in Mbit/s) <sup>[a]</sup>			
				20 MHz channel		40 MHz channel	
				800 ns GI	400 ns GI	800 ns GI	400 ns GI
0	1	BPSK	1/2	6.5	7.2	13.5	15
1	1	QPSK	1/2	13	14.4	27	30
2	1	QPSK	3/4	19.5	21.7	40.5	45
3	1	16-QAM	1/2	26	28.9	54	60
4	1	16-QAM	3/4	39	43.3	81	90
5	1	64-QAM	2/3	52	57.8	108	120
6	1	64-QAM	3/4	58.5	65	121.5	135
7	1	64-QAM	5/6	65	72.2	135	150
8	2	BPSK	1/2	13	14.4	27	30
9	2	QPSK	1/2	26	28.9	54	60
10	2	QPSK	3/4	39	43.3	81	90
11	2	16-QAM	1/2	52	57.8	108	120
12	2	16-QAM	3/4	78	86.7	162	180
13	2	64-QAM	2/3	104	115.6	216	240
14	2	64-QAM	3/4	117	130	243	270
15	2	64-QAM	5/6	130	144.4	270	300
16	3	BPSK	1/2	19.5	21.7	40.5	45
17	3	QPSK	1/2	39	43.3	81	90
18	3	QPSK	3/4	58.5	65	121.5	135
19	3	16-QAM	1/2	78	86.7	162	180

MCS index	Spatial streams	Modulation type	Coding rate	Data rate (in Mbit/s) <sup>[a]</sup>			
				20 MHz channel		40 MHz channel	
				800 ns GI	400 ns GI	800 ns GI	400 ns GI
20	3	16-QAM	3/4	117	130	243	270
21	3	64-QAM	2/3	156	173.3	324	360
22	3	64-QAM	3/4	175.5	195	364.5	405
23	3	64-QAM	5/6	195	216.7	405	450
24	4	BPSK	1/2	26	28.8	54	60
25	4	QPSK	1/2	52	57.6	108	120
26	4	QPSK	3/4	78	86.8	162	180
27	4	16-QAM	1/2	104	115.6	216	240
28	4	16-QAM	3/4	156	173.2	324	360
29	4	64-QAM	2/3	208	231.2	432	480
30	4	64-QAM	3/4	234	260	486	540
31	4	64-QAM	5/6	260	288.8	540	600

MCS – Modulation and Coding Scheme  
 GI – Guard Interval: delay between transmitted symbols

# Break + Open Question

- How much bandwidth is acceptable to use?
  - Is it okay for a WiFi network to use the entire 2.4 GHz spectrum?

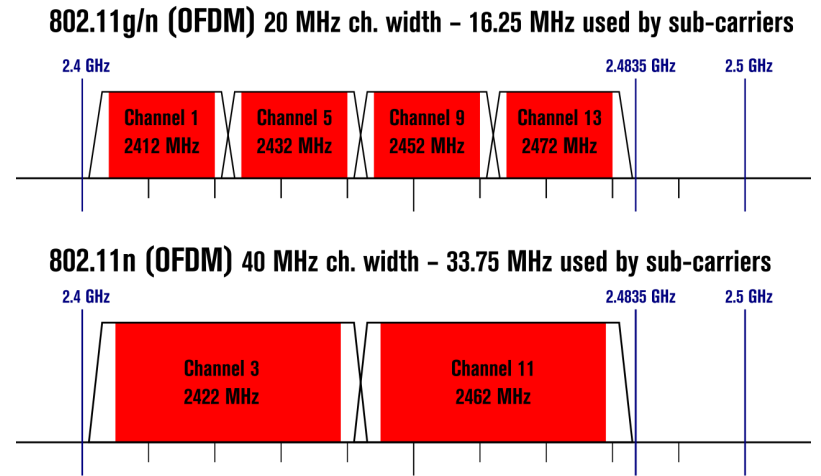

# Break + Open Question

- How much bandwidth is acceptable to use?
  - Is it okay for a WiFi network to use the entire 2.4 GHz spectrum?
  - Maybe. At least the range is pretty short!
    - Only next-door neighbor's network interfere with your network
    - Someone further away isn't affected at all
  - Need to share with neighbors nearby though
    - Theoretically better to have separate allocations than to overlap and deal with the collisions

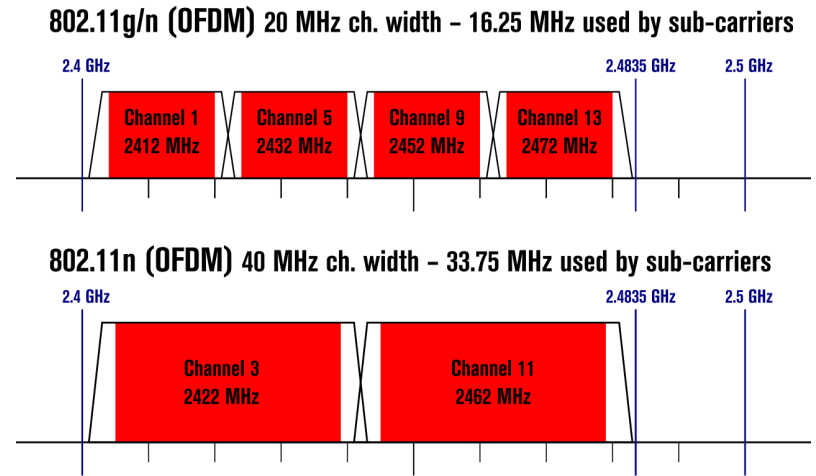

# Walking through PHY changes by amendment

	Protocol	Year	Frequency	PHY	Max Rate	Range
-	802.11	1997	2.4 GHz	DSSS/FHSS	2 Mbps	20 m
1	802.11b	1999	2.4 GHz	DSSS	11 Mbps	35 m
2	802.11a	1999	5 GHz	OFDM	54 Mbps	35 m
3	802.11g	2003	2.4 GHz	OFDM	54 Mbps	38 m
4	802.11n	2009	2.4/5 GHz	OFDM + MIMO	600 Mbps	70 m
5	<b>802.11ac</b>	2013	5 GHz	OFDM + MU-MIMO	3.4 Gbps	35 m
6	802.11ax	2021	2.5/5/[6] GHz	OFDMA + MU-MIMO	9.6 Gbps	35 m
7	802.11be	TBA	2.5/5/6 GHz	OFDMA + MU-MIMO	40 Gbps	35 m



# "The MIMO Gap"

- Access points have 3-4 [or more now] antennas
- Client devices have 1-2 [or more now] antennas
  - While absolute numbers keep going up, trend holds
  - **Asymmetric design pattern** again: More complexity in the AP than clients

- Original MIMO was one device at a time
- Now expand to be multiple devices simultaneously

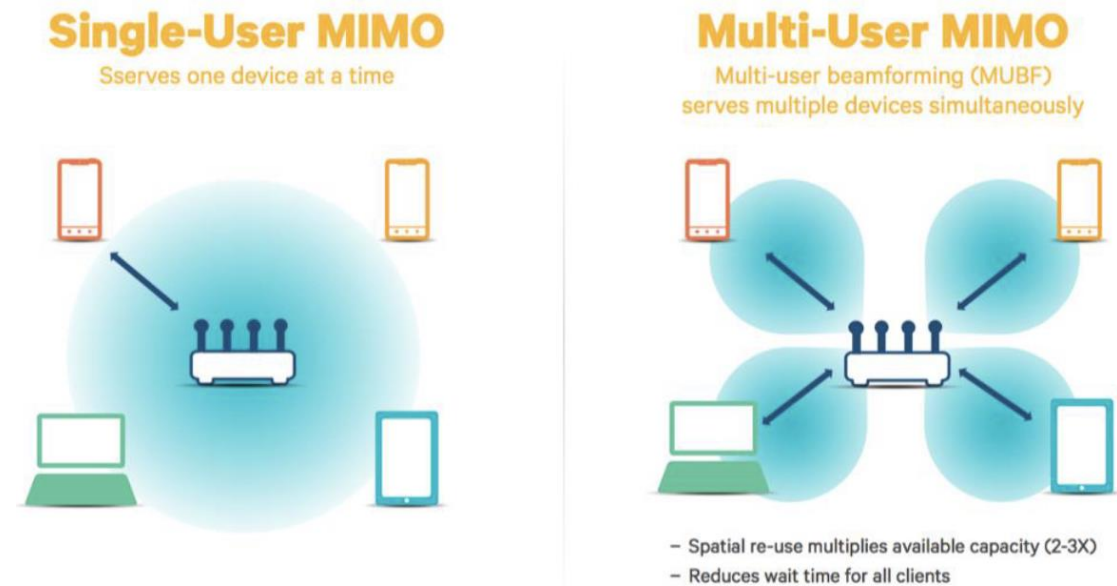
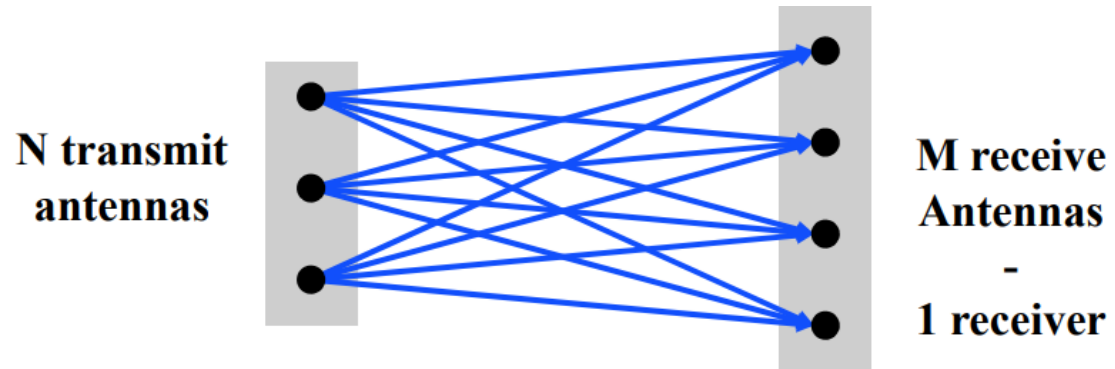
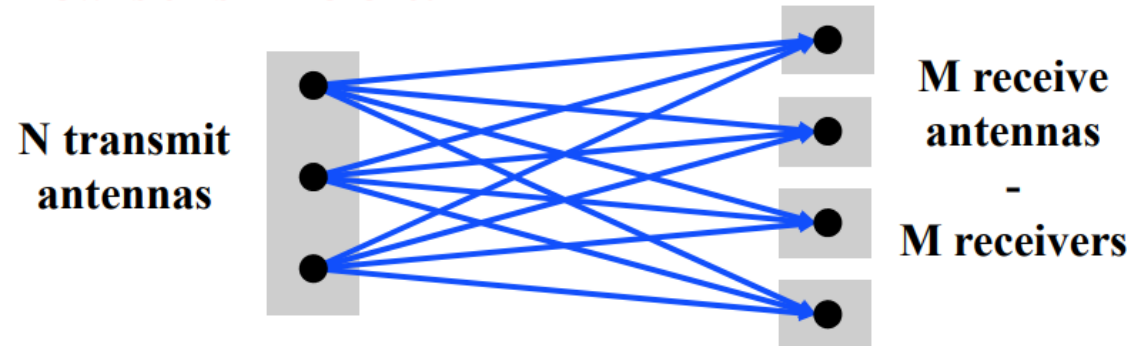

Figure 1. SU-MIMO vs. MU-MIMO

# Multi-user Multiple In Multiple Out (MU-MIMO)



**How is this Different?**



- Multi-user MIMO uses the same techniques to send in parallel to multiple devices
  - Devices cannot cancel out interference anymore
  - Send slower, more reliable data streams to overcome this

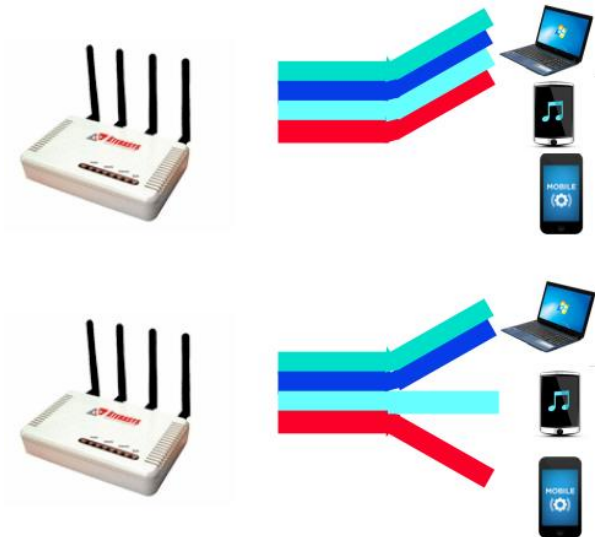

# How much data can a single device use?

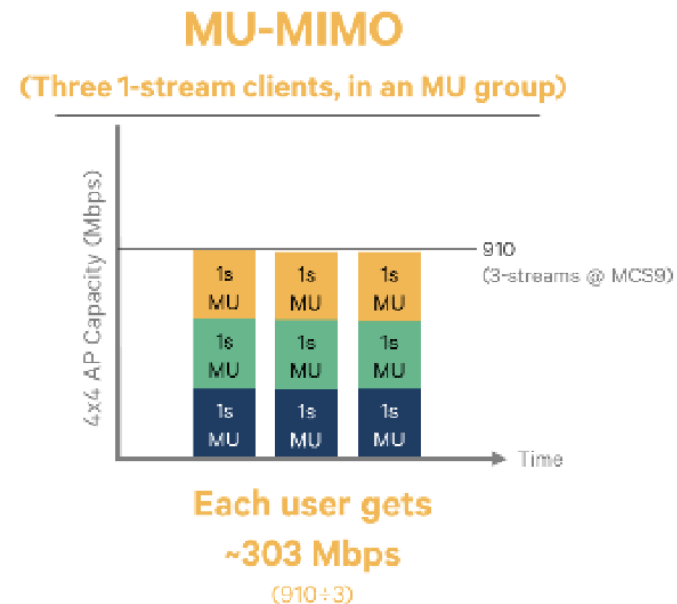
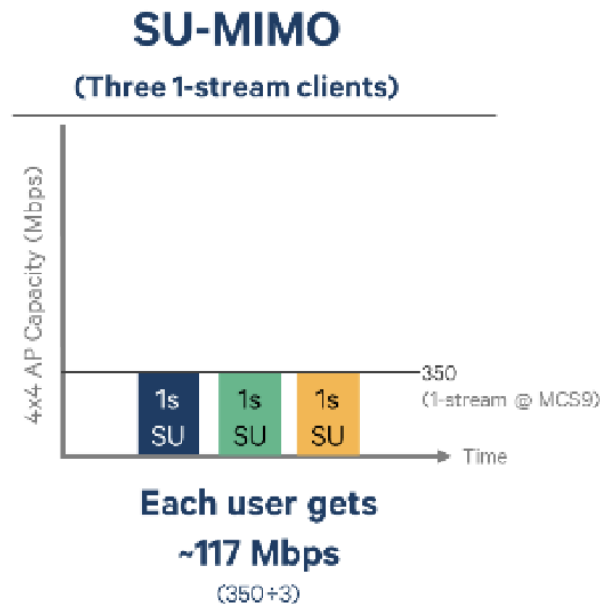
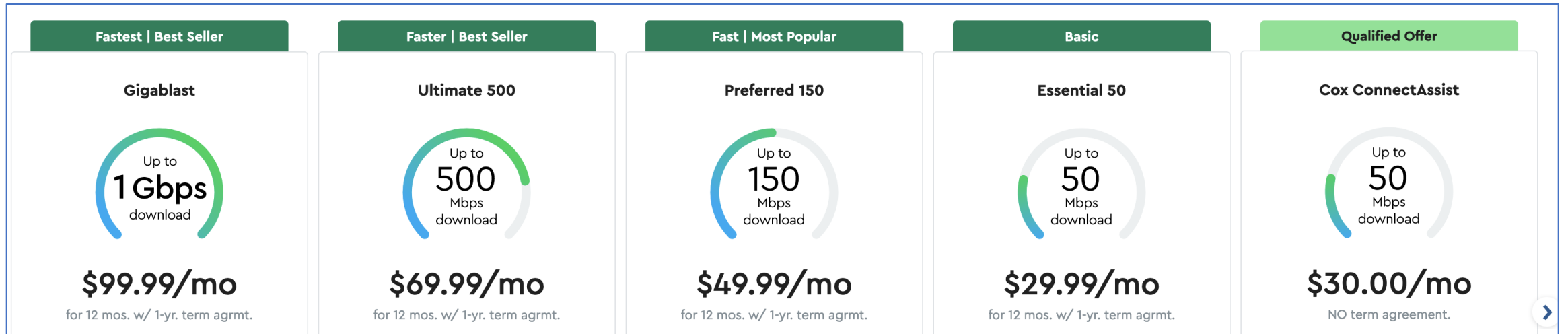

# 802.11ac (2013)

- Update for 5 GHz band only
  - Supports Downlink MU-MIMO (from AP to device)
  - Supports channels widths up to 160 MHz
  - Engineering updates: up to 256-QAM
- Routers apply 802.11ac to 5 GHz and 802.11n to 2.4 GHz
- Still in wide use (as of 2024)
  - Northwestern WiFi networks are 802.11ac (Eduroam, Device, Guest)

# 802.11ac channels

## 802.11ac Channel Allocation (N America)

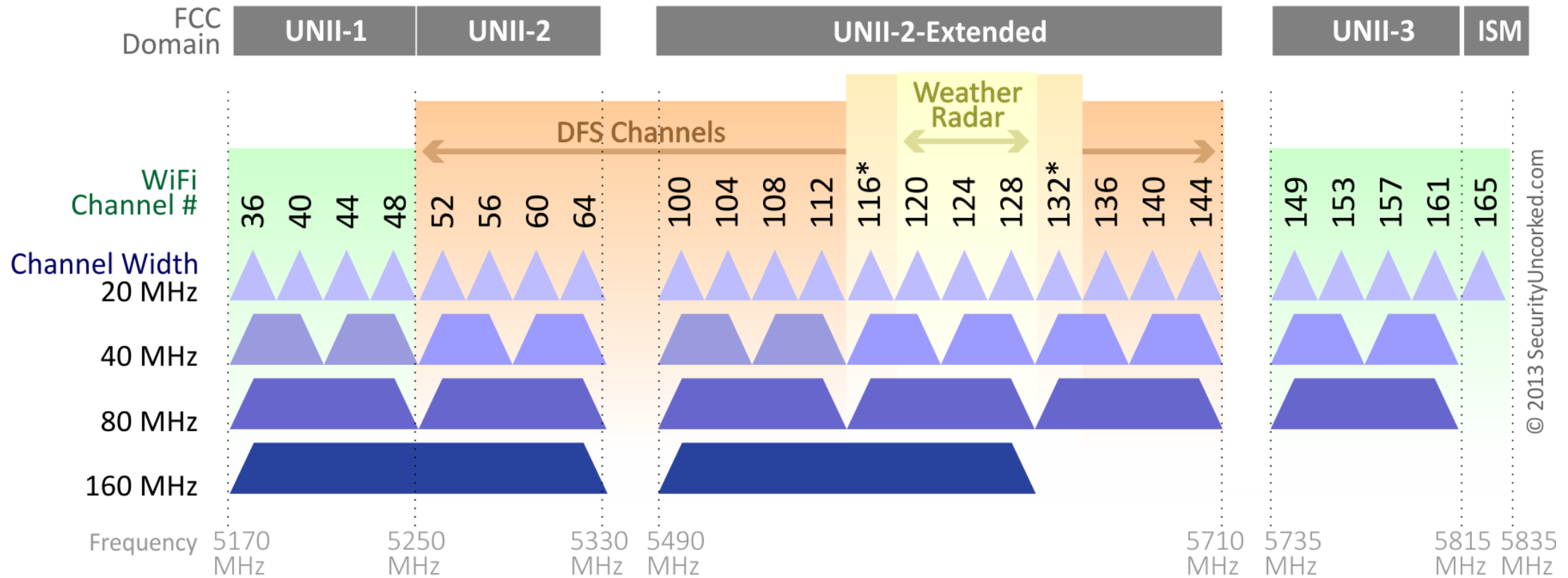

\*Channels 116 and 132 are Doppler Radar channels that may be used in some cases.

© 2013 SecurityUncorked.com

# 802.11ac modulation and coding schemes

802.11ac - VHT

MCS, SNR and RSSI

VHT MCS	Modulation	Coding	20MHz				40MHz				80MHz				160MHz			
			Data Rate		Min. SNR	RSSI	Data Rate		Min. SNR	RSSI	Data Rate		Min. SNR	RSSI	Data Rate		Min. SNR	RSSI
			800ns	400ns			800ns	400ns			800ns	400ns			800ns	400ns		
1 Spatial Stream																		
0	BPSK	1/2	6.5	7.2	2	-82	13.5	15	5	-79	29.3	32.5	8	-76	58.5	65	11	-73
1	QPSK	1/2	13	14.4	5	-79	27	30	8	-76	58.5	65	11	-73	117	130	14	-70
2	QPSK	3/4	19.5	21.7	9	-77	40.5	45	12	-74	87.8	97.5	15	-71	175.5	195	18	-68
3	16-QAM	1/2	26	28.9	11	-74	54	60	14	-71	117	130	17	-68	234	260	20	-65
4	16-QAM	3/4	39	43.3	15	-70	81	90	18	-67	175.5	195	21	-64	351	390	24	-61
5	64-QAM	2/3	52	57.8	18	-66	108	120	21	-63	234	260	24	-60	468	520	27	-57
6	64-QAM	3/4	58.5	65	20	-65	121.5	135	23	-62	263.3	292.5	26	-59	526.5	585	29	-56
7	64-QAM	5/6	65	72.2	25	-64	135	150	28	-61	292.5	325	31	-58	585	650	34	-55
8	256-QAM	3/4	78	86.7	29	-59	162	180	32	-56	351	390	35	-53	702	780	38	-50
9	256-QAM	5/6			31	-57	180	200	34	-54	390	433.3	37	-51	780	866.7	40	-48
2 Spatial Streams																		
0	BPSK	1/2	13	14.4	2	-82	27	30	5	-79	58.5	65	8	-76	117	130	11	-73
1	QPSK	1/2	26	28.9	5	-79	54	60	8	-76	117	130	11	-73	234	260	14	-70
2	QPSK	3/4	39	43.3	9	-77	81	90	12	-74	175.5	195	15	-71	351	390	18	-68
3	16-QAM	1/2	52	57.8	11	-74	108	120	14	-71	234	260	17	-68	468	520	20	-65
4	16-QAM	3/4	78	86.7	15	-70	162	180	18	-67	351	390	21	-64	702	780	24	-61
5	64-QAM	2/3	104	115.6	18	-66	216	240	21	-63	468	520	24	-60	936	1040	27	-57
6	64-QAM	3/4	117	130.3	20	-65	243	270	23	-62	526.5	585	26	-59	1053	1170	29	-56
7	64-QAM	5/6	130	144.4	25	-64	270	300	28	-61	585	650	31	-58	1170	1300	34	-55
8	256-QAM	3/4	156	173.3	29	-59	324	360	32	-56	702	780	35	-53	1404	1560	38	-50
9	256-QAM	5/6			31	-57	360	400	34	-54	780	866.7	37	-51	1560	1733.3	40	-48
3 Spatial Streams																		
0	BPSK	1/2	19.5	21.7	2	-82	40.5	45	5	-79	87.8	97.5	8	-76	175.5	195	11	-73
1	QPSK	1/2	39	43.3	5	-79	81	90	8	-76	175.5	195	11	-73	351	390	14	-70
2	QPSK	3/4	58.5	65	9	-77	121.5	135	12	-74	263.3	292.5	15	-71	526.5	585	18	-68
3	16-QAM	1/2	78	86.7	11	-74	162	180	14	-71	351	390	17	-68	702	780	20	-65
4	16-QAM	3/4	117	130	15	-70	243	270	18	-67	526.5	585	21	-64	1053	1170	24	-61
5	64-QAM	2/3	156	173.3	18	-66	324	360	21	-63	702	780	24	-60	1404	1560	27	-57
6	64-QAM	3/4	175.5	195	20	-65	364.5	405	23	-62			26	-59	1579.5	1755	29	-56
7	64-QAM	5/6	195	216.7	25	-64	405	450	28	-61	877.5	975	31	-58	1755	1950	34	-55
8	256-QAM	3/4	234	260	29	-59	486	540	32	-56	1053	1170	35	-53	2106	2340	38	-50
9	256-QAM	5/6	260	288.9	31	-57	540	600	34	-54	1170	1300	37	-51			40	-48

4 spatial streams is also allowed, getting up to 3466 Mbps

# Walking through PHY changes by amendment

	Protocol	Year	Frequency	PHY	Max Rate	Range
-	802.11	1997	2.4 GHz	DSSS/FHSS	2 Mbps	20 m
1	802.11b	1999	2.4 GHz	DSSS	11 Mbps	35 m
2	802.11a	1999	5 GHz	OFDM	54 Mbps	35 m
3	802.11g	2003	2.4 GHz	OFDM	54 Mbps	38 m
4	802.11n	2009	2.4/5 GHz	OFDM + MIMO	600 Mbps	70 m
5	802.11ac	2013	5 GHz	OFDM + MU-MIMO	3.4 Gbps	35 m
6	<b>802.11ax</b>	2021	2.5/5/[6] GHz	OFDMA + MU-MIMO	9.6 Gbps	35 m
7	<b>802.11be</b>	TBA	2.5/5/6 GHz	OFDMA + MU-MIMO	40 Gbps	35 m

New directions in WiFi focus:

Aggregate throughput across all devices

- For point-to-point, WiFi is “(more than) fast enough”
- Now the problem is the quantity of devices in a single space
  - Desktop, laptop, tablet, smartphone, smartwatch, IoT devices, etc.
- Insight: Bring established cellular techniques to WiFi



# Orthogonal Frequency Division Multiple Access

- OFDM: split channel into subcarriers and transmit on those
- OFDMA: allocate subcarriers to a device for an amount of time
  - Turns OFDM into an access control mechanism (frequency + time)
  - Complicated question: which device gets which subcarriers at which time?

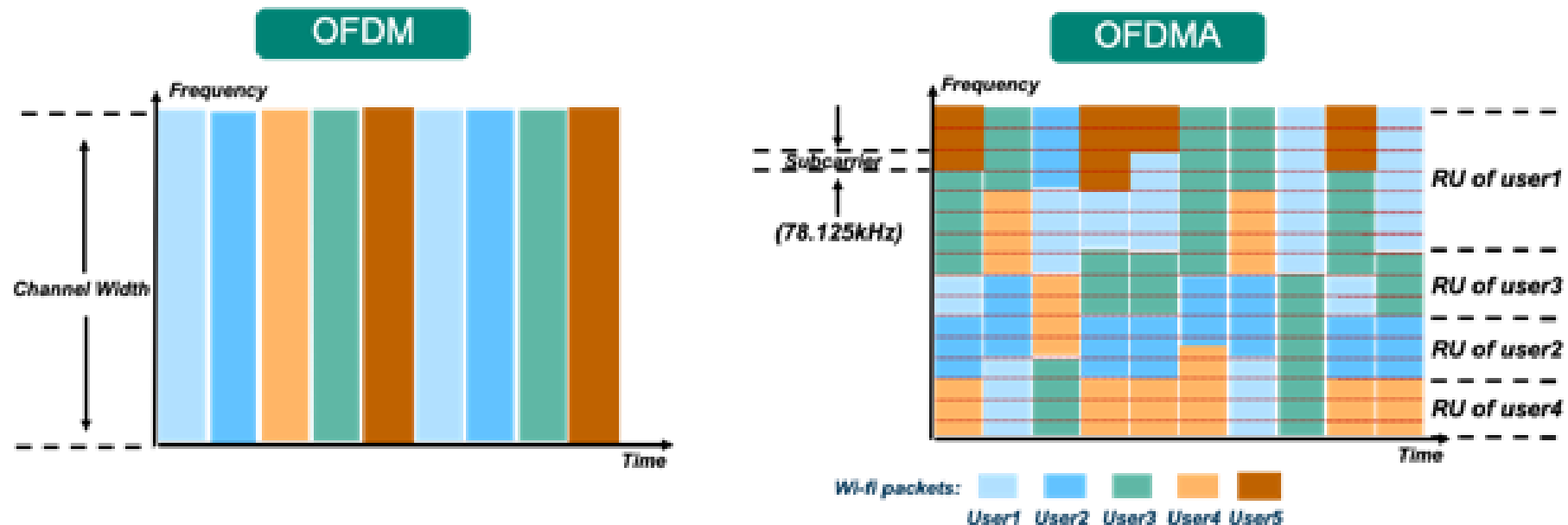

# OFDM vs OFDMA

Orthogonal Frequency Division Multiplexing vs. Orthogonal Frequency Division Multiple Access

- Net spectrum usage ~the same
- In same time slot, assign sub-carriers to different users
  - Effect: Lower bandwidth per user, but more simultaneous users
- This is the same strategy cellular “resource blocks” use
  - Called “Resource Units” in WiFi

# 802.11ax (2021)

- Standard approved in February 2021
  - First devices started supporting it in 2019 (WiFi 6)
- 6 GHz band (WiFi 6E)
  - 1.2 GHz of bandwidth (5.925-7.125 GHz)
  - 2020: US FCC made band available for unlicensed use!!!
  - EU followed by June 2021
- OFDMA
  - MAC scheduling variant of OFDM
  - AP schedules devices based on time and subcarrier allocations

# 6 GHz band is an enormous amount of bandwidth

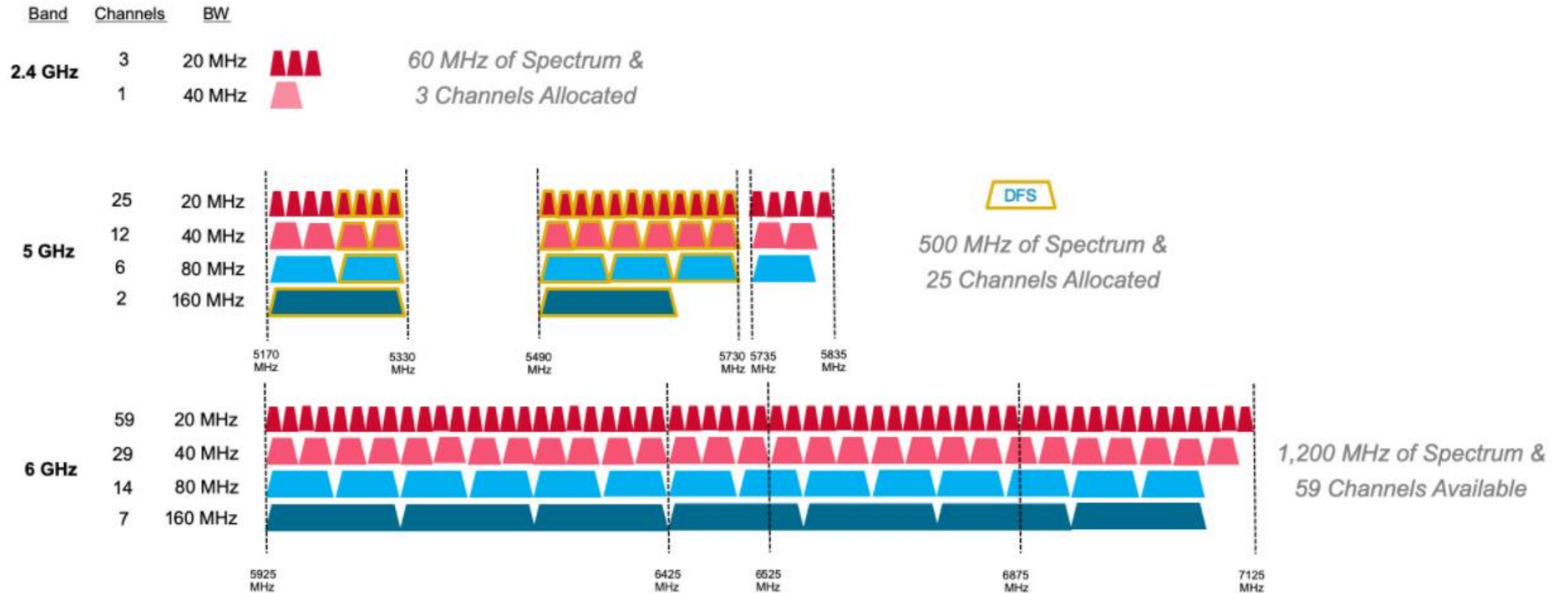

# Less bandwidth in the 6 GHz band in Europe

## 6 GHz Channels in United States & Europe/CEPT

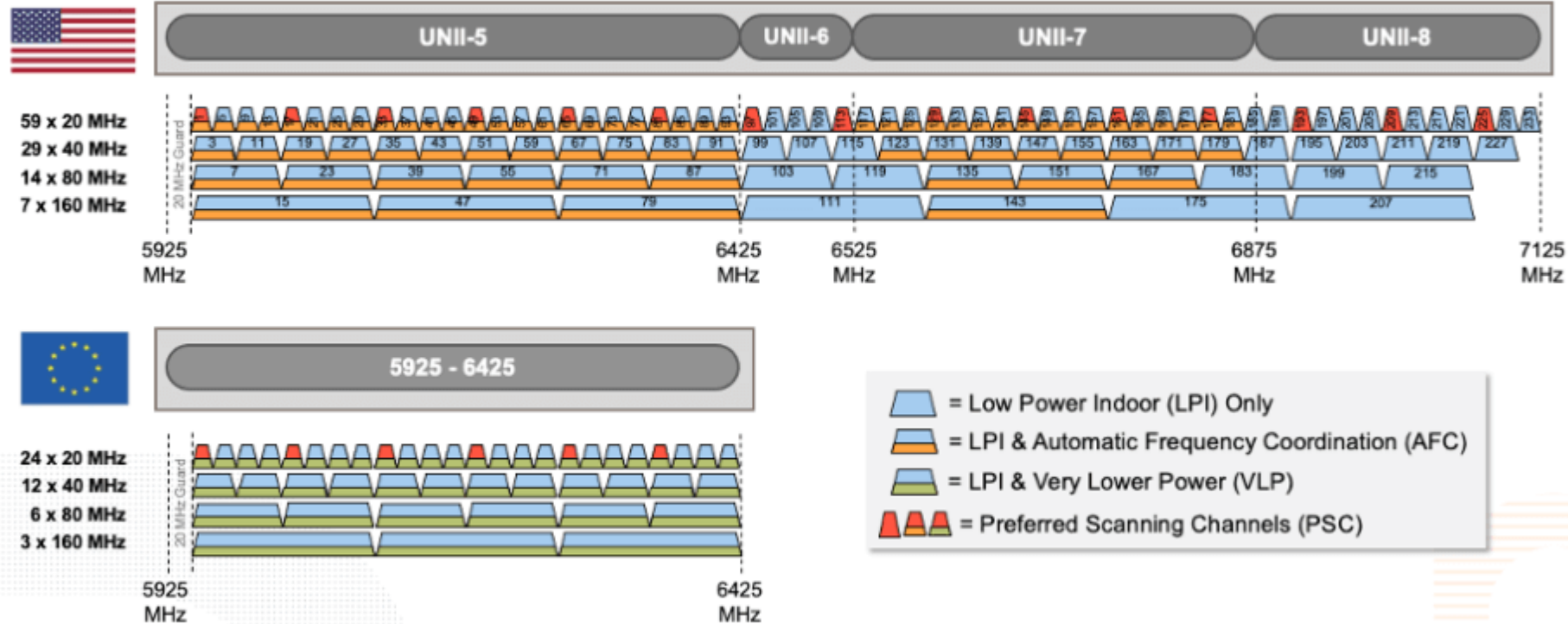

# Reminder: WiFi technology (and to some extent cellular) a unicorn – HW support rolls out *before* specification

Standard Finalized: Sep 2020  
Standard Ratified: Feb 2021

Model	802.11ax	802.11v	802.11r	802.11k
iPhone 13 Pro Max	✓	✓	✓	✓
iPhone 13 Pro				
iPhone 13				
iPhone 13 mini				
iPhone 12 Pro Max	✓	✓	✓	✓
iPhone 12 Pro				
iPhone 12				
iPhone 12 mini				
iPhone 11 Pro Max	✓	✓	✓	✓
iPhone 11 Pro				
iPhone 11				
iPhone Xs Max		✓	✓	✓
iPhone Xs				
iPhone Xr				
iPhone X				

Release: Sep 2019 →

# WiFi 6 Hardware

- Two varieties:
  - WiFi 6
    - Most of the features, but NOT the new frequencies
  - WiFi 6E
    - Includes the extra 6 GHz channels
    - Basically entirely unused as of 2023
- WiFi 6E is the stuff you want for future proofing
  - Devices capable of 6E started rolling out in 2022-2023
    - iPhone 15 (2023), Macbooks 2023 and newer
    - Google Pixel 6 (2022) and newer

# What's coming next: 802.11.be

- Still in flux, "WiFi 7" aka "Extremely High Throughput" (EHT)
- Essentially: more of everything
  - More channel bonding / wider bandwidth: up to 320 MHz
  - Up to 4096-QAM
  - Up to 16-stream MIMO
- New features
  - AP coordination for non-enterprise networks
  - Lots of fancy timing estimation stuff (802.1Q)
    - Primary focus seems to be AV-streaming Quality-of-Service (QoS)
- Plan to standardize by end of 2024



# Outline

- **WiFi Overview**
- WiFi PHY
  - 802.11/802.11b
  - 802.11a/802.11g
  - 802.11n/802.11ac
  - 802.11ax
- **Real-World WiFi**

# Goal: improve throughput

- In twenty years, WiFi has gone from 2 Mbps to 9.6 Gbps
  - **How does a network PHY improve its throughput?**
1. More capable modulation and/or bit transmission
    - Techniques like OFDM and MIMO
      - Original 2 Mbps -> 54 Mbps with OFDM -> 346 Mbps with MIMO **(100x)**
      - Engineering improvements are baked into these steps too
  2. More bandwidth
    - Increased channel width at 2.4 GHz and bigger 5 GHz channels
      - 346 Mbps with 20 MHz -> 3466 Mbps with 160 MHz **(10x)**

# Bit rate adaptation

- All modern WiFi standards support multiple bit rates (MCS)
- Many factors can influence the choice of bit rate
  - Capability of device: not all devices support all bit rates
  - Range and packet reliability (interference)

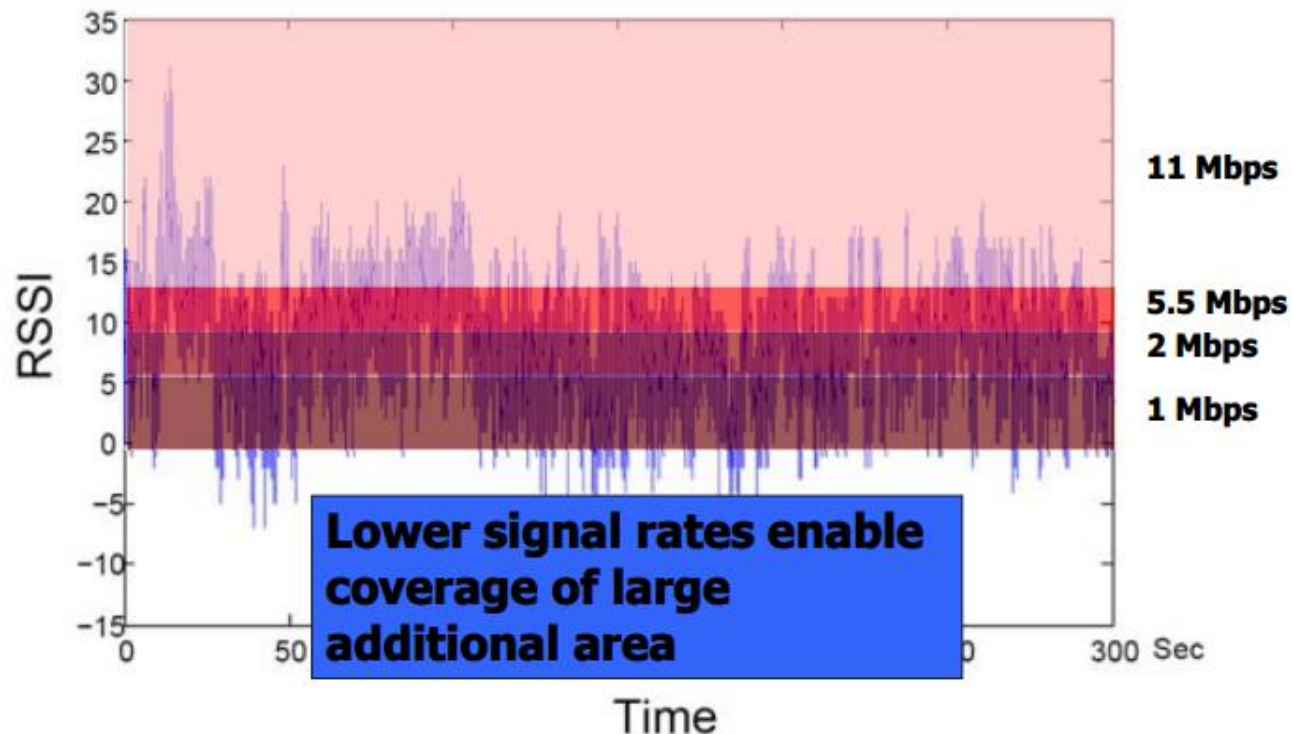

# Bit rate adaptation

- Selecting the right rate at the right time is a complex problem
  - And needs to be decided per-device
- Trial and Error
  - Failures -> reduce rate
  - Successes -> increase rate
- Signal strength
  - Use channel state information to decide
- Context sensitive
  - Mobile devices can use lower rates for higher reliability

# Real-world 802.11 channel use – 2.4 Ghz

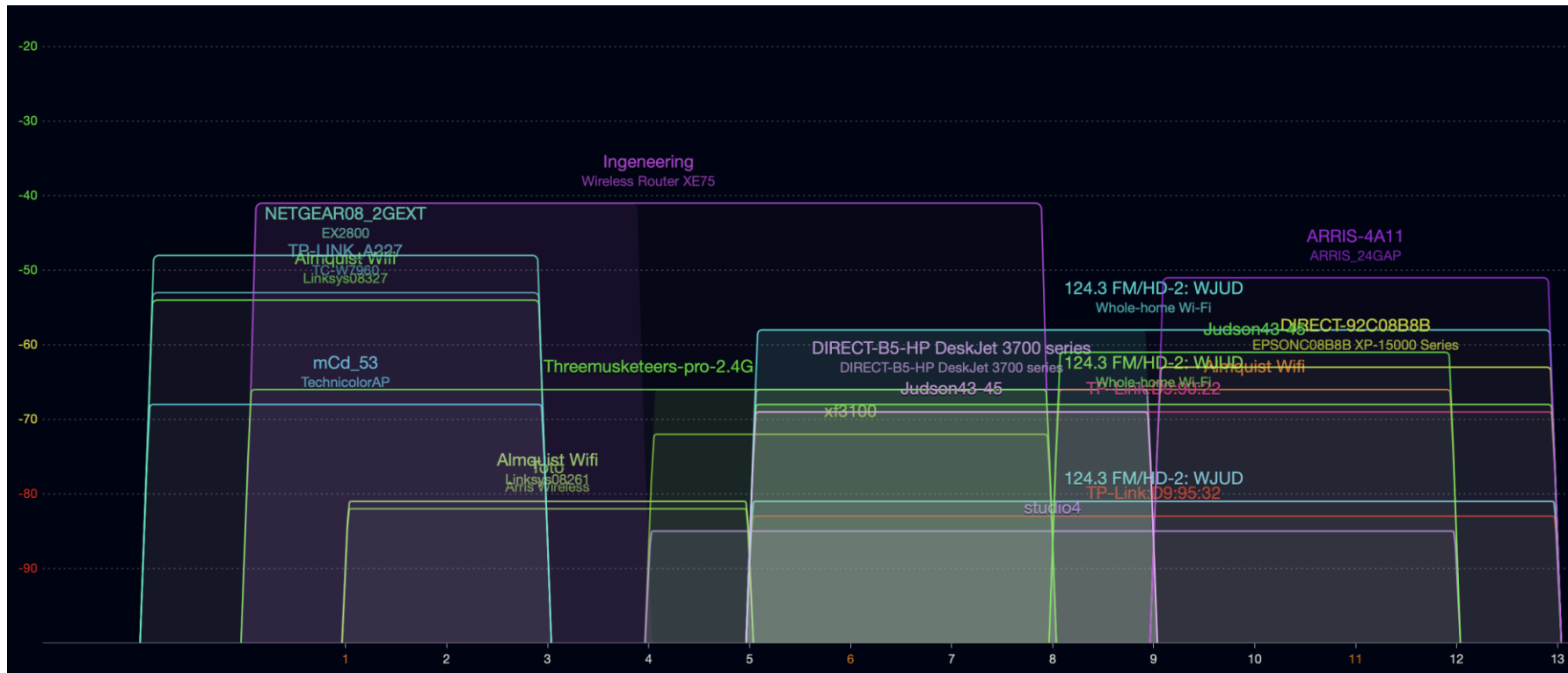

Collected from  
Branden's prior  
apartment building  
in Evanston

Tool: [WiFi Explorer](#)  
(MacOS only)

On Android try  
["WiFiAnalyzer"](#)

- Lots of congestion
  - Some devices only use 20 MHz bandwidth (mostly on channel 1 or 11 here)
  - Some devices use 40 MHz bandwidth (<1 through 8, or 5-13)

# Some real-world devices are weird



- Why make a 40 MHz allocation centered on channel 6??
- Similarly, some 20 MHz networks use channels 2, 9, or 10

# Real-world 802.11 channel use – 5 Ghz

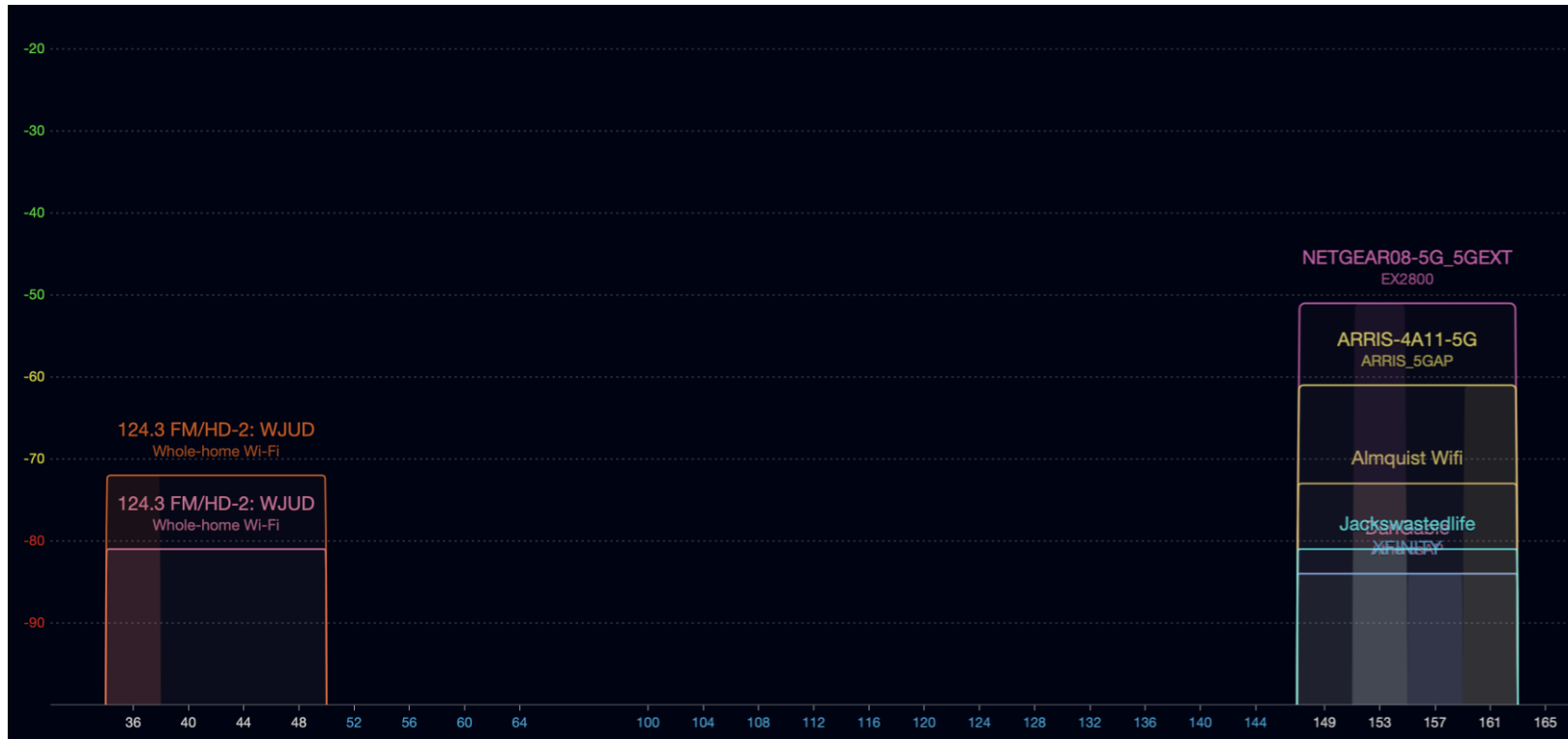

- Much less choice
  - 80 MHz bandwidth on lower channels or upper channels
  - **Why no use of channel 165?**

# Real-world 802.11 channel use – 5 Ghz

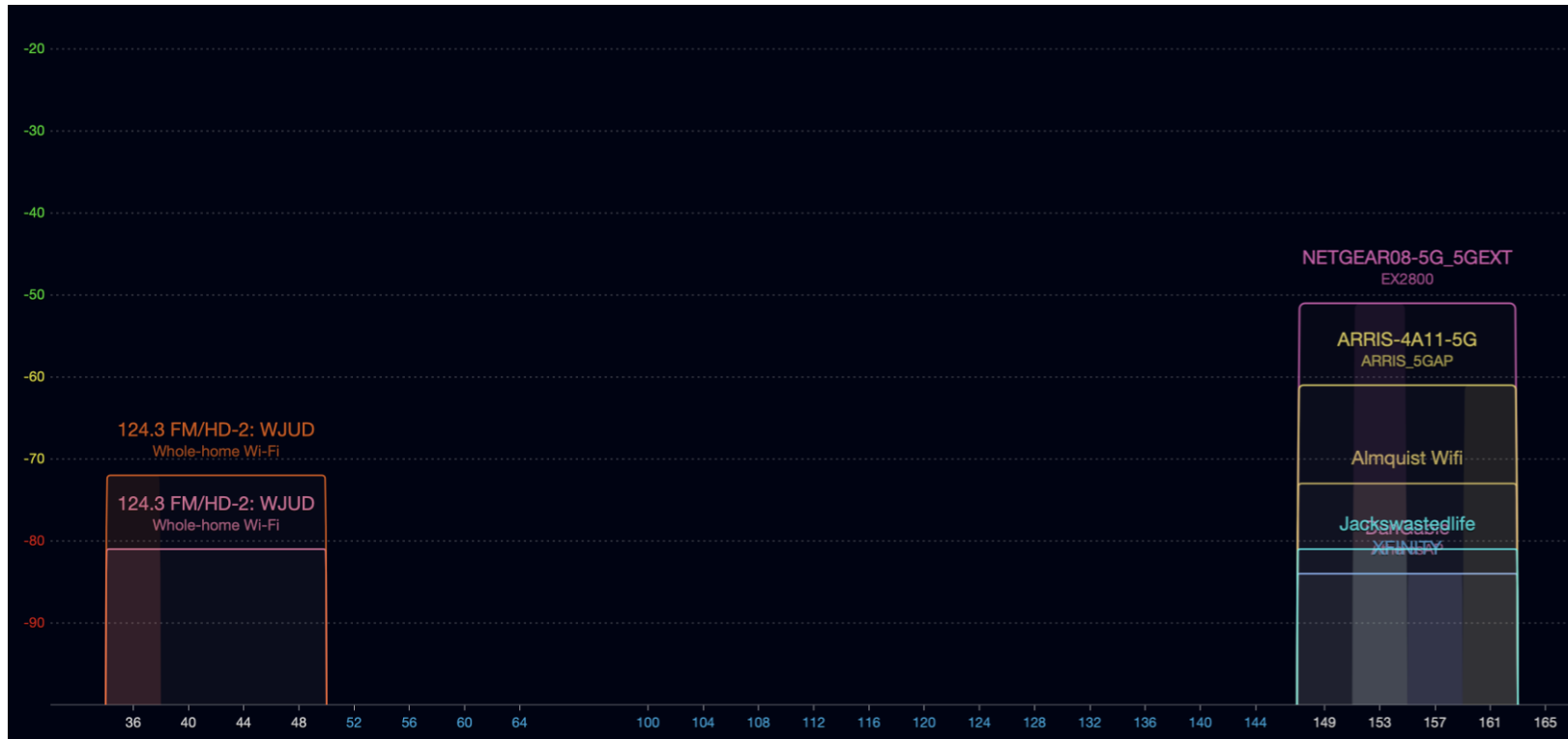

- Much less choice
  - 80 MHz bandwidth on lower channels or upper channels
  - **Why no use of channel 165?** Only 20 MHz, can't be 100 MHz in size



# What does a new, (moderately) expensive router get you?

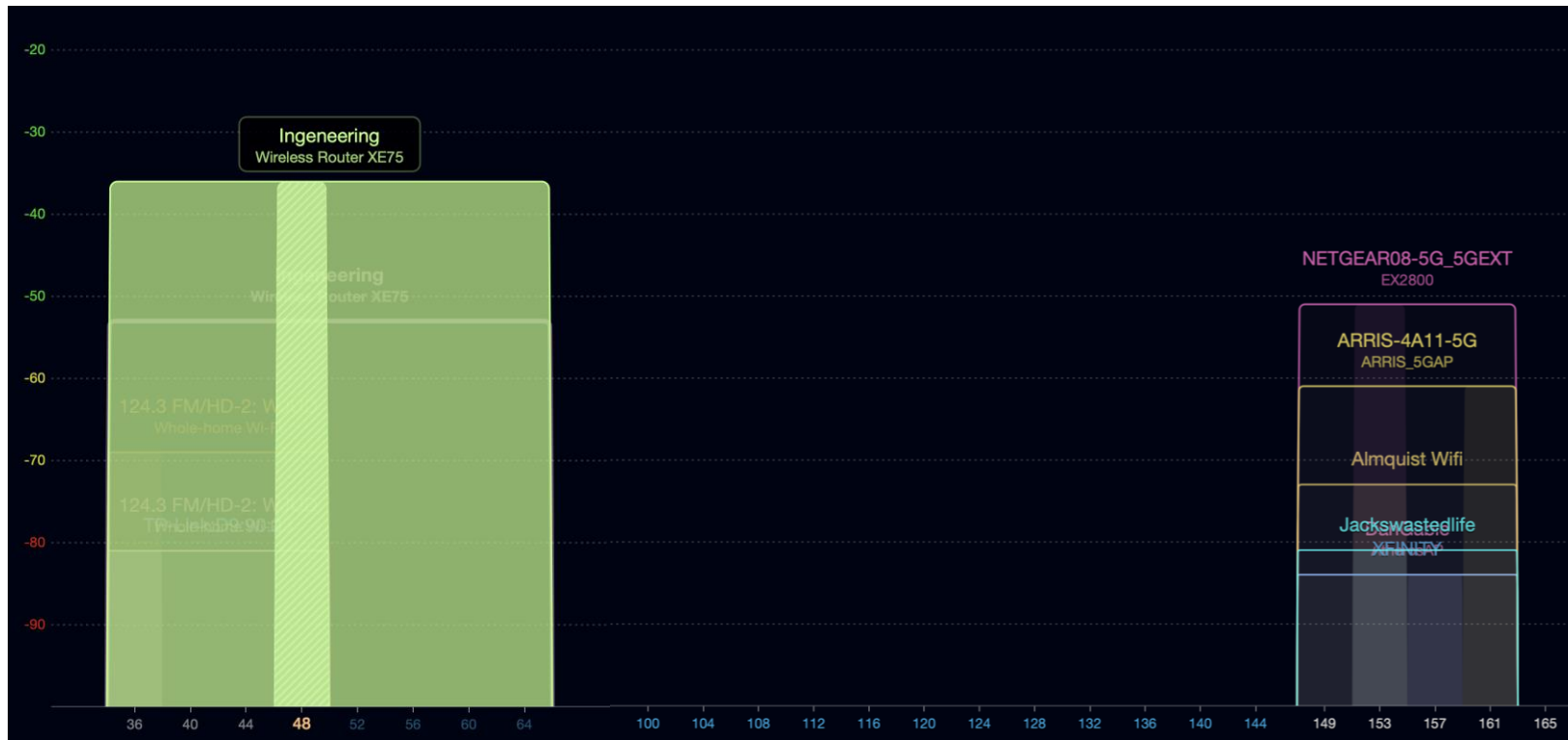

TP-Link Deco XE75  
WiFi 6E with Mesh

<https://www.tp-link.com/us/deco-mesh-wifi/product-family/deco-xe75/>

- 160 MHz bandwidth channel 🦋
- Uses channels 52-64 which have special rules
  - Must detect radar use and leave channel if it occurs (DFS)
  - Must control transmission power between devices (TPC)
- Also has a 160 MHz bandwidth allocation on channels 33-61 of the 6 GHz space
  - My scans showed no other network in the 6 GHz bands

# Outline

- WiFi Overview
- WiFi PHY
  - 802.11/802.11b
  - 802.11a/802.11g
  - 802.11n/802.11ac
  - 802.11ax
- Real-World WiFi