

Lecture 09

Sensors

CE346 – Microprocessor System Design
Branden Ghena – Fall 2021

Some slides borrowed from:
Josiah Hester (Northwestern), Prabal Dutta (UC Berkeley)

Administrivia

- Every group should have now received feedback from me on their proposals
- Project Design presentations will be next week **Thursday**
 - I'll provide details tomorrow

Today's Goals

- Think about sensing and sensors
- Explore a variety of sensor types, how they are made, and what their capabilities are
- Discuss an example research platform with a custom sensor

Outline

- **Sensing Overview**
- Types of Sensors
 - Temperature
 - Light
 - Inertial
 - Others
- Research case study

Definitions

- A **sensor** is a device that measures a physical quantity
 - Temperature sensor
 - Light sensor
 - Microphone

- An **actuator** is a device that modifies a physical quantity
 - Heater
 - Motor
 - Speaker

Sensors transform quantity into an electric signal

- Microcontrollers can interact with analog signals
 - Generating an analog signal proportional to physical quantity makes the quantity able to be sensed
- How do we generate an electrical signal?
 - Ohm's Law: $V = I * R$ (Voltage = Current * Resistance)
 - Vary any one of these three and an analog signal is created

Resistive sensors

$$R = \frac{\rho L}{A}$$

- L: length of the conductor
 - A: area of the conductor
 - ρ : resistivity of the conductor material
-
- Various materials have resistivity that is itself a function
 - Based on temperature, light, strain, etc.

Using a resistive sensor

- Place in series with another resistor
 - Between VCC and ground
- Measure voltage between the two relative to ground
- Forms a "voltage divider"

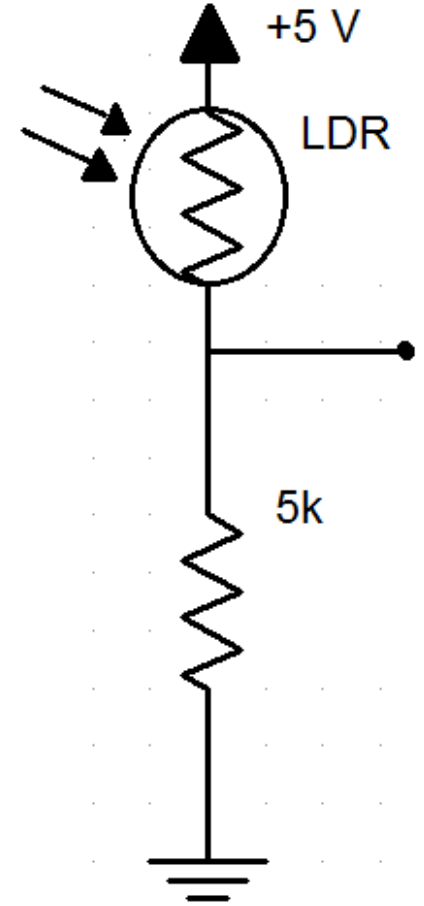
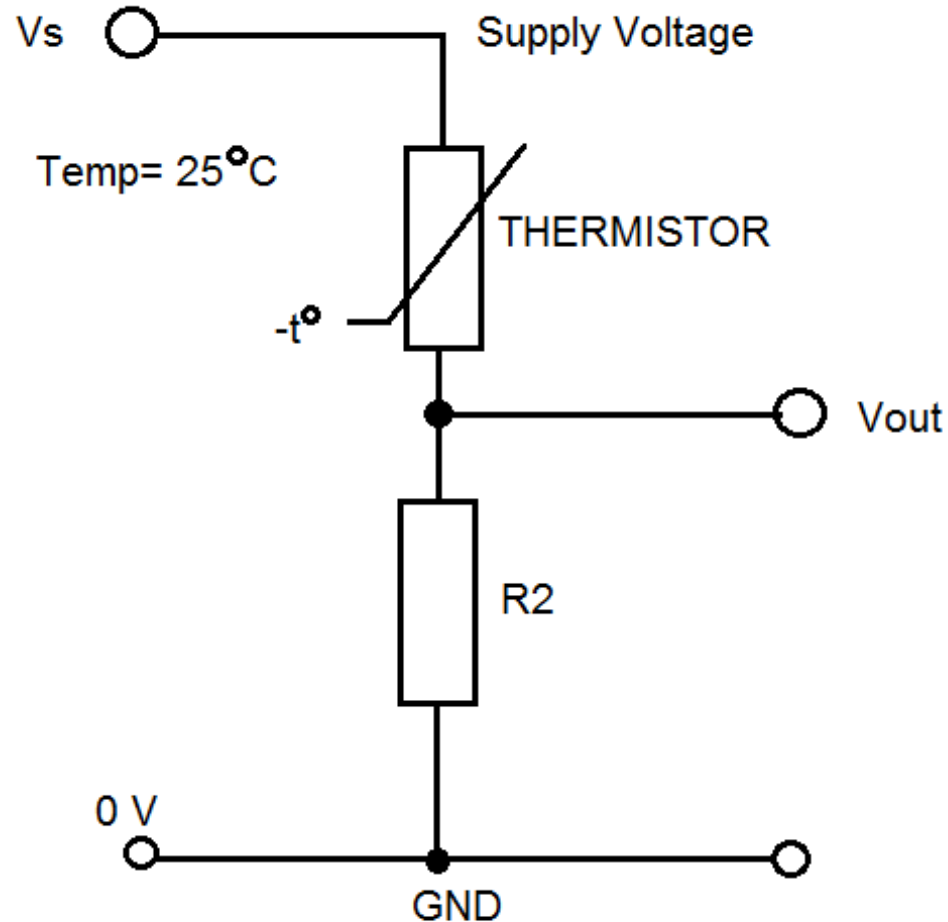

Voltage divider

- $V_{out} = \frac{R_2}{R_1 + R_2} * V_{in}$
 - V_{in} is a voltage source
 - R_1 and R_2 are resistors
- If $R_1 == R_2$
 - $V_{out} = V_{in}/2$
- Smaller R_1 means larger V_{out}
 - V_{out} approaches V_{in}

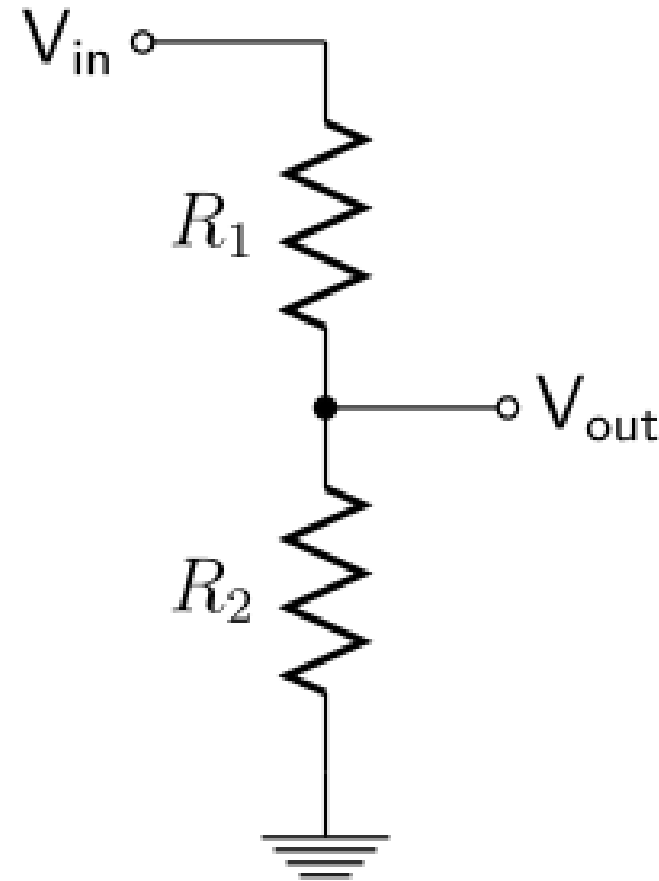

Generating voltage via piezoelectric effect

- Compression of the material generates a voltage
- Various sources of compression:
 - Air Pressure
 - Acceleration
 - Strain

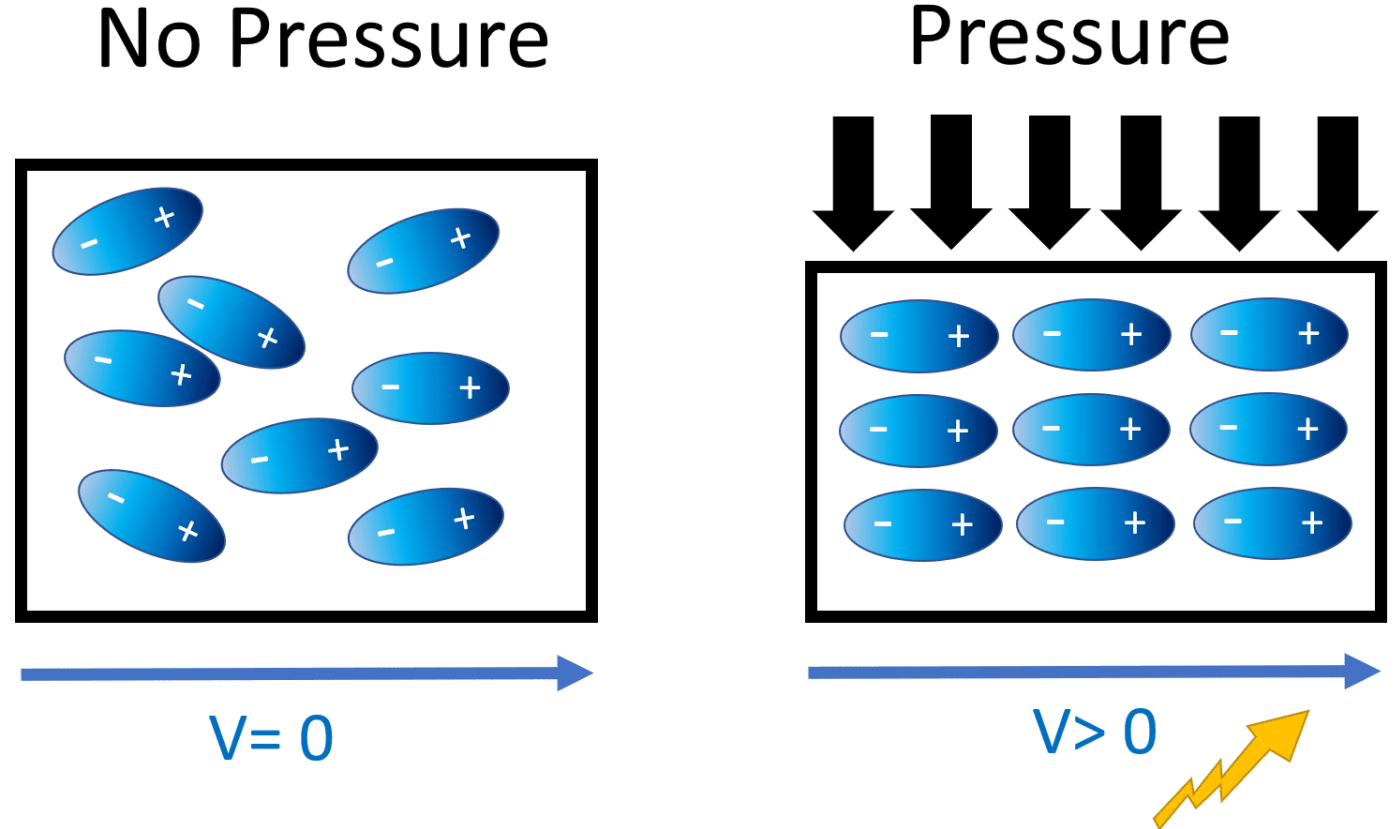

Understanding sensor voltage

- Once you get a voltage, what do you do with it?
- Need to understand the transfer function between voltage and the sensed quantity
 - Examples for an accelerometer: senses acceleration
- Hopefully, function is linear
 - Occasionally, function is NOT

Affine sensor model (for linear sensors)

$$F(x) = ax + b$$

- x is the quantity being sensed
- $F(x)$ is a voltage proportional to that quantity
- Parameters
 - a : sensitivity, units Volts/quantity
 - Change in voltage per change in quantity
 - b : bias, units Volts
 - Offset in voltage for zero of the quantity

Bias and sensitivity example

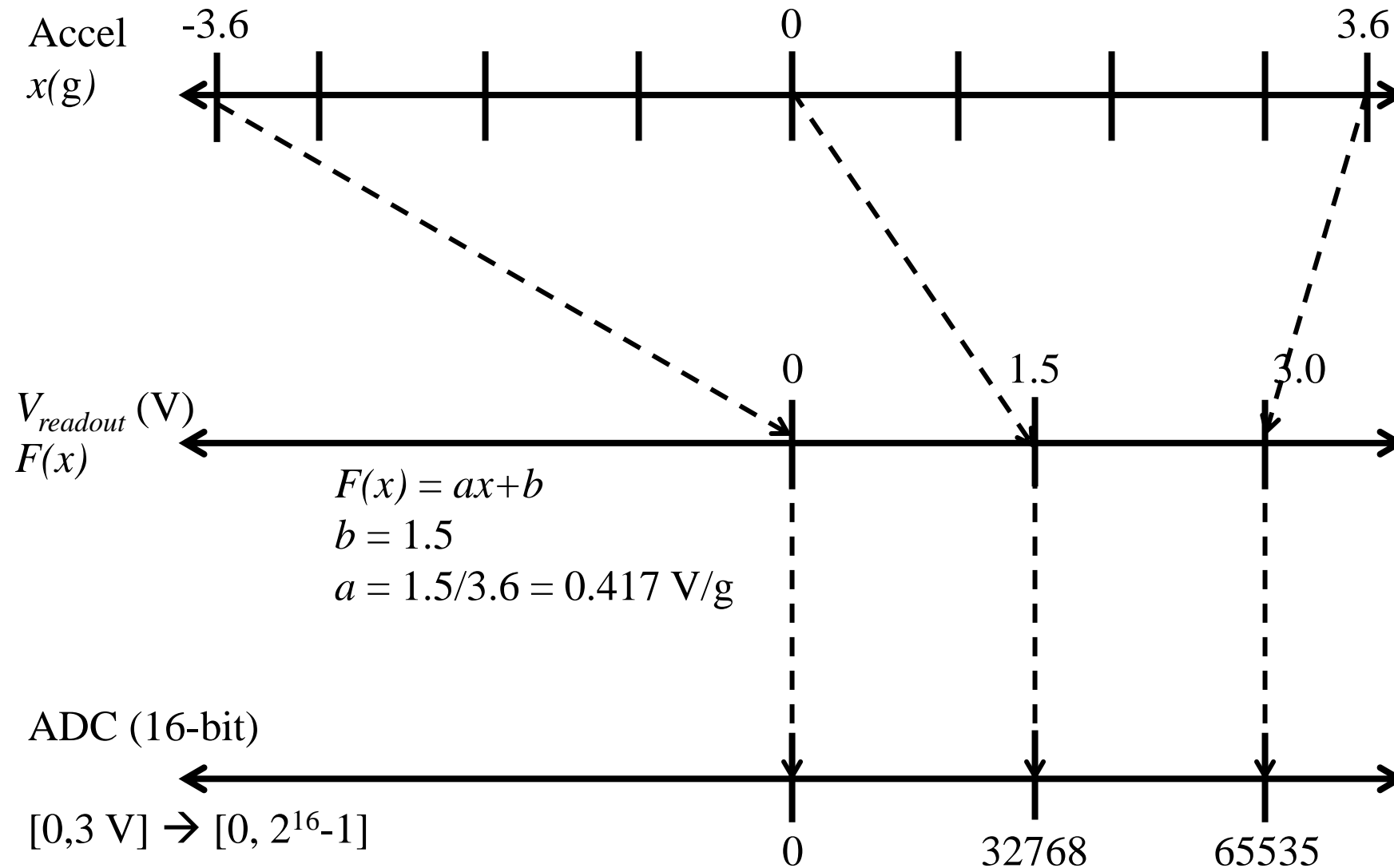

Understanding transfer function: ADXL330 datasheet

- Ratiometric
 - Relative to sensor voltage
- Bandwidth
 - Data update speed of the sensor

SPECIFICATIONS

$T_A = 25^\circ\text{C}$, $V_S = 3\text{ V}$, $C_X = C_Y = C_Z = 0.1\ \mu\text{F}$, acceleration = 0 g, unless otherwise noted. All minimum and maximum specifications are guaranteed. Typical specifications are not guaranteed.

Table 1.

Parameter	Conditions	Min	Typ	Max	Unit
SENSOR INPUT	Each axis				
Measurement Range		± 3	± 3.6		g
Nonlinearity	% of full scale		± 0.3		%
Package Alignment Error			± 1		Degrees
Inter-Axis Alignment Error			± 0.1		Degrees
Cross Axis Sensitivity ¹			± 1		%
SENSITIVITY (RATIOMETRIC)²	Each axis				
Sensitivity at X_{OUT} , Y_{OUT} , Z_{OUT}	$V_S = 3\text{ V}$	270	300	330	mV/g
Sensitivity Change Due to Temperature ³	$V_S = 3\text{ V}$		± 0.015		%/ $^\circ\text{C}$
ZERO g BIAS LEVEL (RATIOMETRIC)	Each axis				
0 g Voltage at X_{OUT} , Y_{OUT} , Z_{OUT}	$V_S = 3\text{ V}$	1.2	1.5	1.8	V
0 g Offset vs. Temperature			± 1		mg/ $^\circ\text{C}$
NOISE PERFORMANCE					
Noise Density X_{OUT} , Y_{OUT}			280		$\mu\text{g}/\sqrt{\text{Hz}}$ rms
Noise Density Z_{OUT}			350		$\mu\text{g}/\sqrt{\text{Hz}}$ rms
FREQUENCY RESPONSE⁴					
Bandwidth X_{OUT} , Y_{OUT} ⁵	No external filter		1600		Hz
Bandwidth Z_{OUT} ⁵	No external filter		550		Hz
R_{FILT} Tolerance			$32 \pm 15\%$		k Ω
Sensor Resonant Frequency			5.5		kHz

Active and passive sensing

Passive Sensing

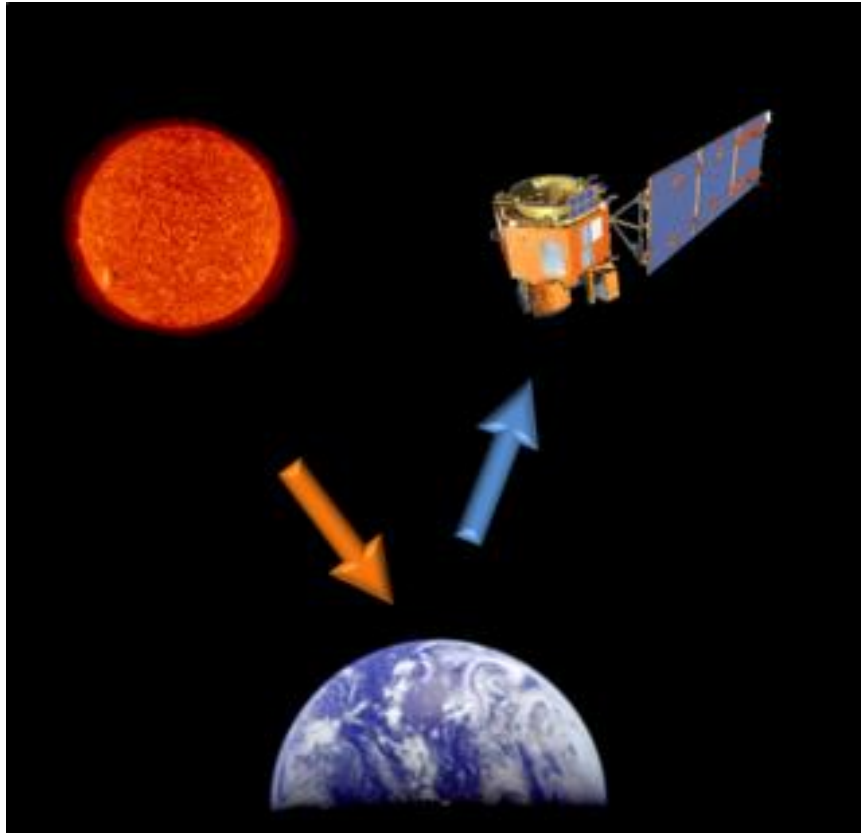

Active Sensing

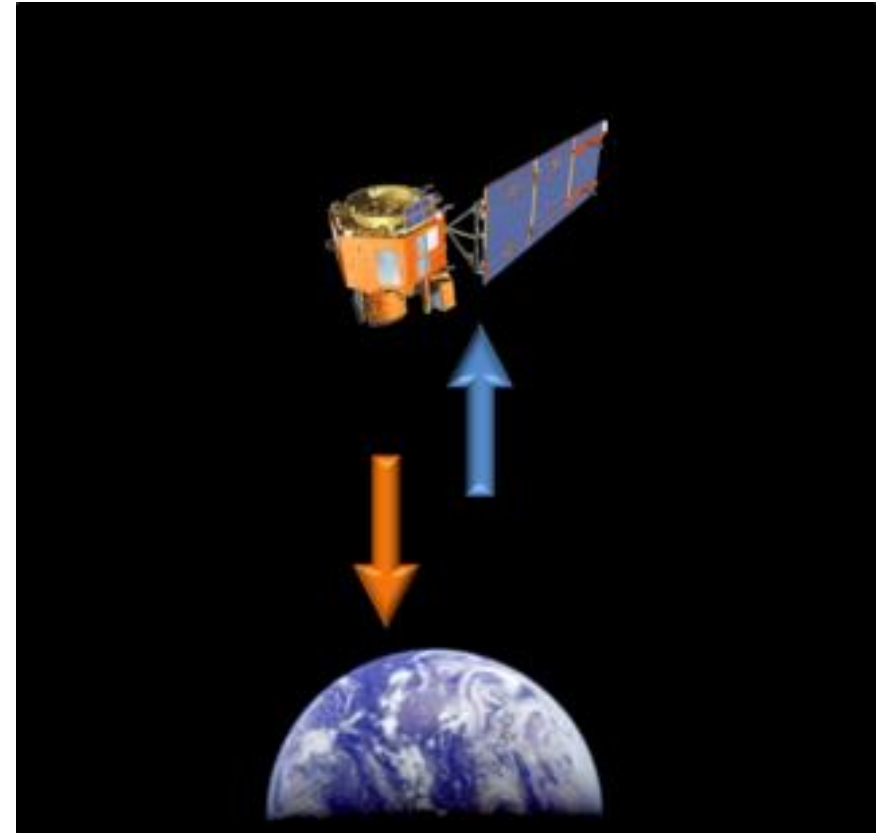

Active and passive sensing

- We usually focus on passive sensing
 - Cheaper and lower energy costs!

- Active sensing examples
 - Flash photography
 - Ultrasonic distance sensing
 - Lidar and Radar

Intelligent sensors

- Many embedded sensors are more intelligent than simple analog
- Combine it with a built-in ADC
 - Can be more finely tuned and calibrated for accuracy
 - Now gives digital output over some wired communication mechanism
- Combine it with additional circuitry / computation
 - Automatically filter data
 - Detect specific signal patterns and interrupt
- I pointed most groups at intelligent sensors (QWIIC)

Break + Question

- Accelerometer
 - Measures 0-5 g
 - Over a 0-5v range
- What is sensitivity?
- What is bias?
- What acceleration is the voltage reading 3.5 volts?

Break + Question

- Accelerometer
 - Measures 0-5 g
 - Over a 0-5v range
- What is sensitivity? 1 v/g
- What is bias? 0 v
- What acceleration is the voltage reading 3.5 volts?
 - $3.5 \text{ v} = 1\text{v/g} * x + 0\text{v} \rightarrow 3.5 \text{ g}$

Outline

- Sensing Overview
- **Types of Sensors**
 - **Temperature**
 - Light
 - Inertial
 - Others
- Research case study

Digital temperature sensor

- **Thermostat**

- Original meaning of the word
- Heat bends a strip of two different metals
- Switches circuit on/off based on the temperature

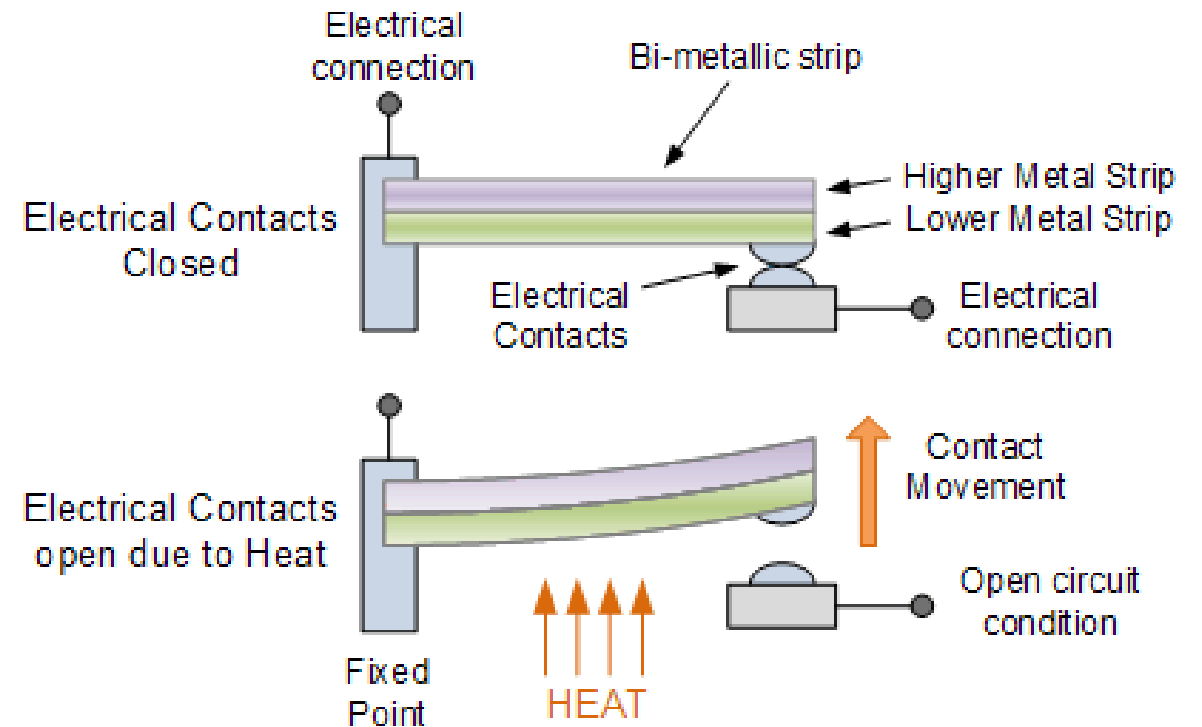

Thermo-electric temperature sensing

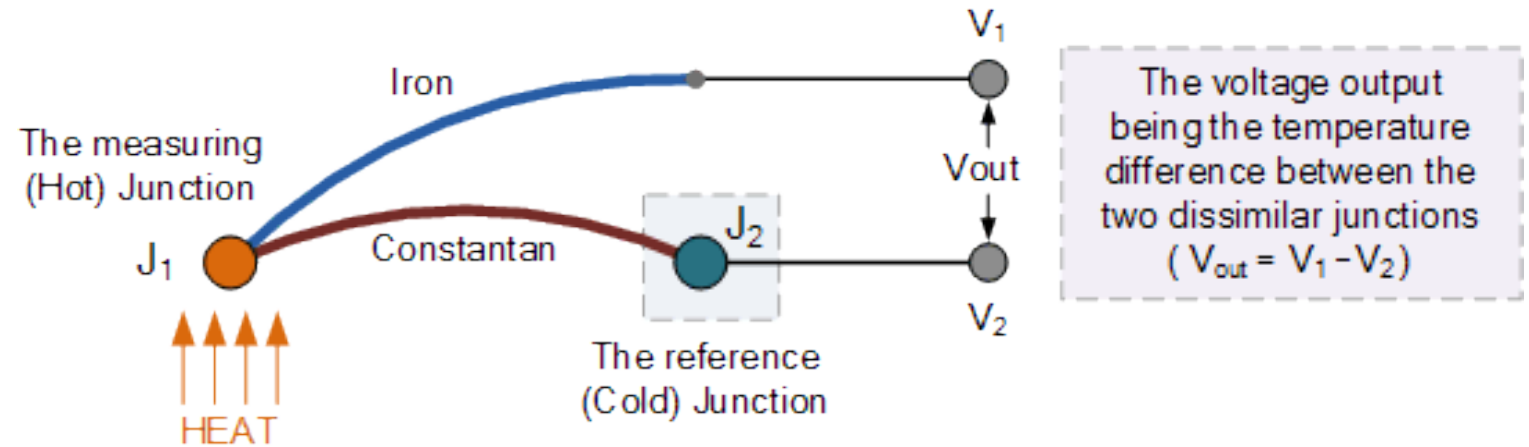

- **Thermocouple** generates a voltage based on temperature
- Can be used to harvest energy to run system
 - Part of RTG design

Resistive temperature sensing

- **Thermistor** varies resistance based on temperature
- Set up as a voltage divider to measure
- Advantages: extremely cheap and easy to use
- Disadvantages: non-linear transfer function

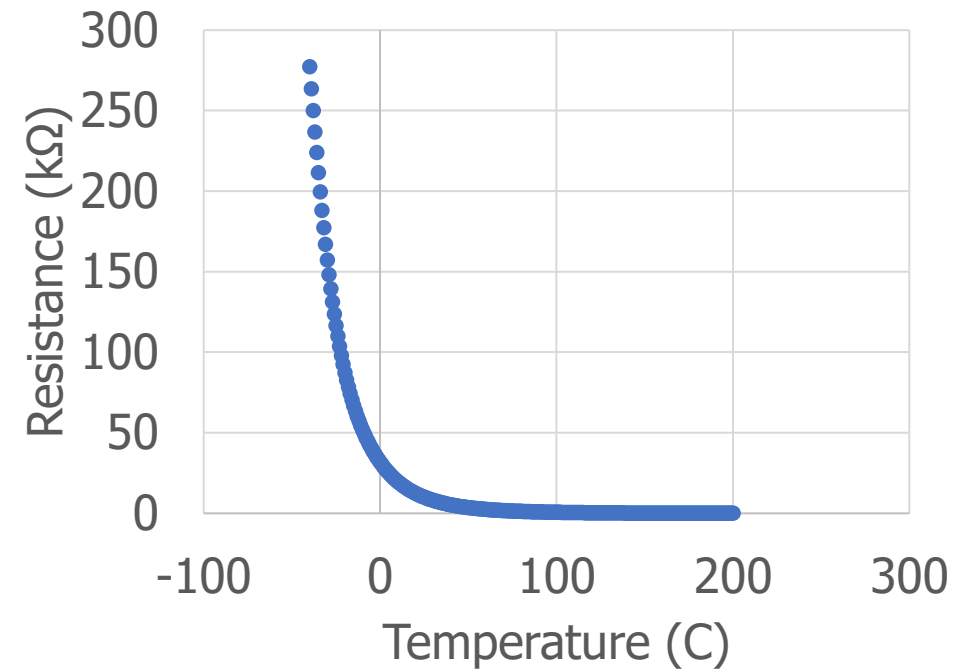

Outline

- Sensing Overview
- **Types of Sensors**
 - Temperature
 - **Light**
 - Inertial
 - Others
- Research case study

Measuring light

- Lux: unit of illuminance
- Beware spectrum sensitivity

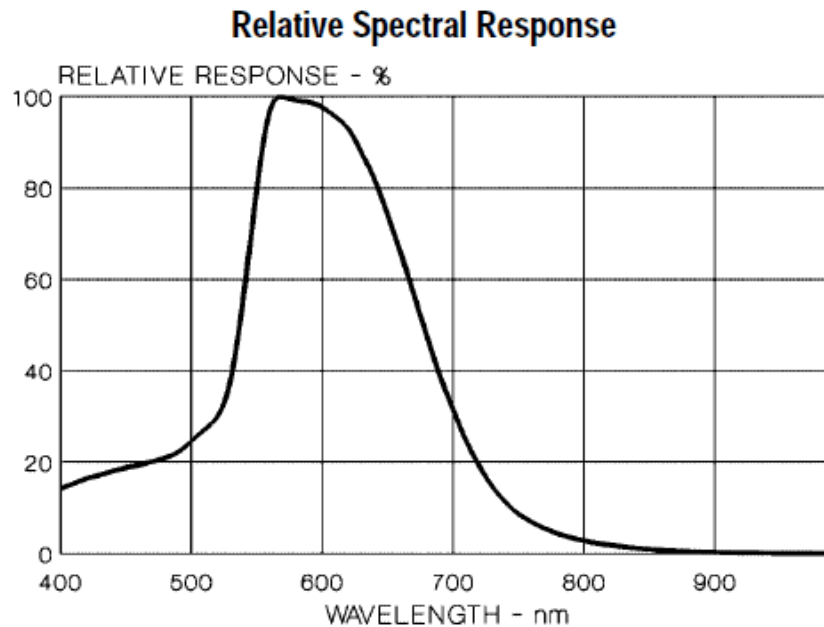

Illuminance	Example
0.002 lux	Moonless clear night sky
0.2 lux	Design minimum for emergency lighting (AS2293).
0.27 - 1 lux	Full moon on a clear night
3.4 lux	Dark limit of civil twilight under a clear sky
50 lux	Family living room
80 lux	Hallway/toilet
100 lux	Very dark overcast day
300 - 500 lux	Sunrise or sunset on a clear day. Well-lit office area.
1,000 lux	Overcast day; typical TV studio lighting
10,000 - 25,000 lux	Full daylight (not direct sun)
32,000 - 130,000 lux	Direct sunlight

Resistive light sensing

- **Photocell** changes resistance with light (non-linear)

ABSOLUTE MAXIMUM RATING (TA)= 23°C UNLESS OTHERWISE NOTED

SYMBOL	PARAMETER	MIN	MAX	UNITS
V_{pk}	Applied Voltage		150	V
$P_{d \Delta po/\Delta t}$	Continuous Power Dissipation		100	mW/°C
T_O	Operating and Storage Temperature	-30	+75	°C
T_S	Soldering Temperature*		+260	°C

* 0.200 inch from base for 3 seconds with heat sink.

ELECTRO-OPTICAL CHARACTERISTICS RATING (TA)= 23°C UNLESS OTHERWISE NOTED

SYMBOL	CHARACTERISTIC	TEST CONDITIONS	MIN	TYP	MAX	UNITS
R_D	Dark Resistance	After 10 sec. @ 10 Lux @ 2856 °K	0.2			MΩ
R_l	Illuminated Resistance	10 Lux @ 2856 °K	3		11	KΩ
S	Sensitivity	$\frac{\text{LOG}(R_{100})-\text{LOG}(R_{10})^{**}}{\text{LOG}(E_{100})-\text{LOG}(E_{10})^{***}}$		0.6		Ω/Lux
λ_{range}	Spectral Application Range	Flooded	400		700	nm
λ_{peak}	Spectral Application Range	Flooded		520		nm
t_r	Rise Time	10 Lux @ 2856 °K		55		ms
T_f	Fall Time	After 10 Lux @ 2856 °K		20		ms

**R100, R10: cell resistances at 100 Lux and 10 Lux at 2856 °K respectively .

***E100, E10: luminances at 100 Lux and 10 Lux 2856 °K respectively.

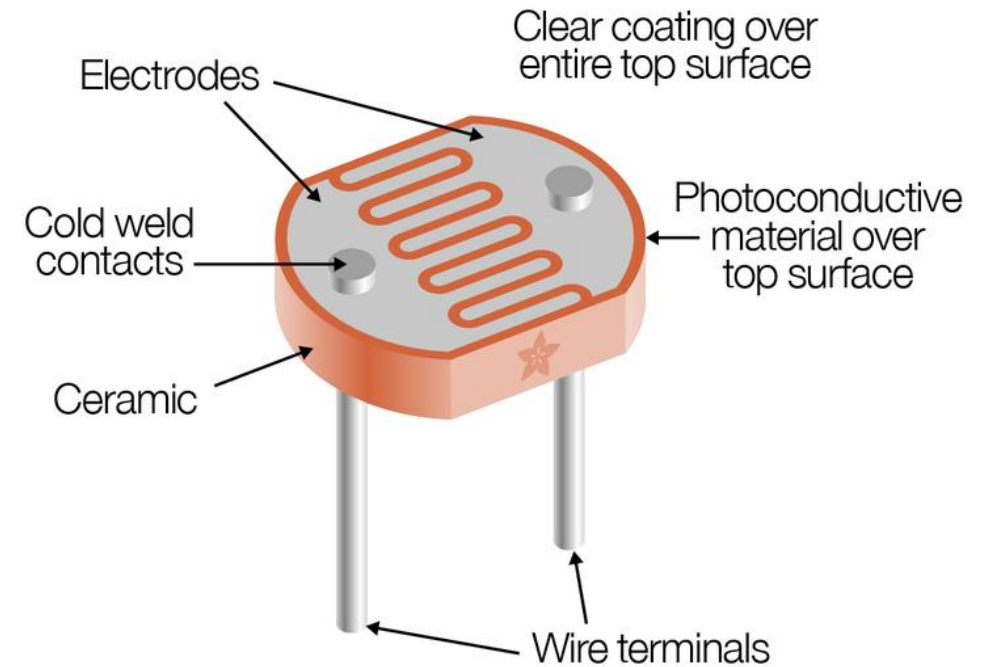

Kit version:

- 10 kΩ when dark
- 1 kΩ when light

Photodiodes leak current based on light levels

- When voltage is applied in reverse to an ideal diode, no current flows
- But some small amount of current leaks for real-world diodes
 - Proportional to light levels!
- LEDs can be used as (crappy) photodiodes as well!
 - Apply reverse voltage
 - Read in leak current as voltage across a resistor using ADC

<https://wiki.analog.com/university/courses/electronics/electronics-lab-led-sensor>

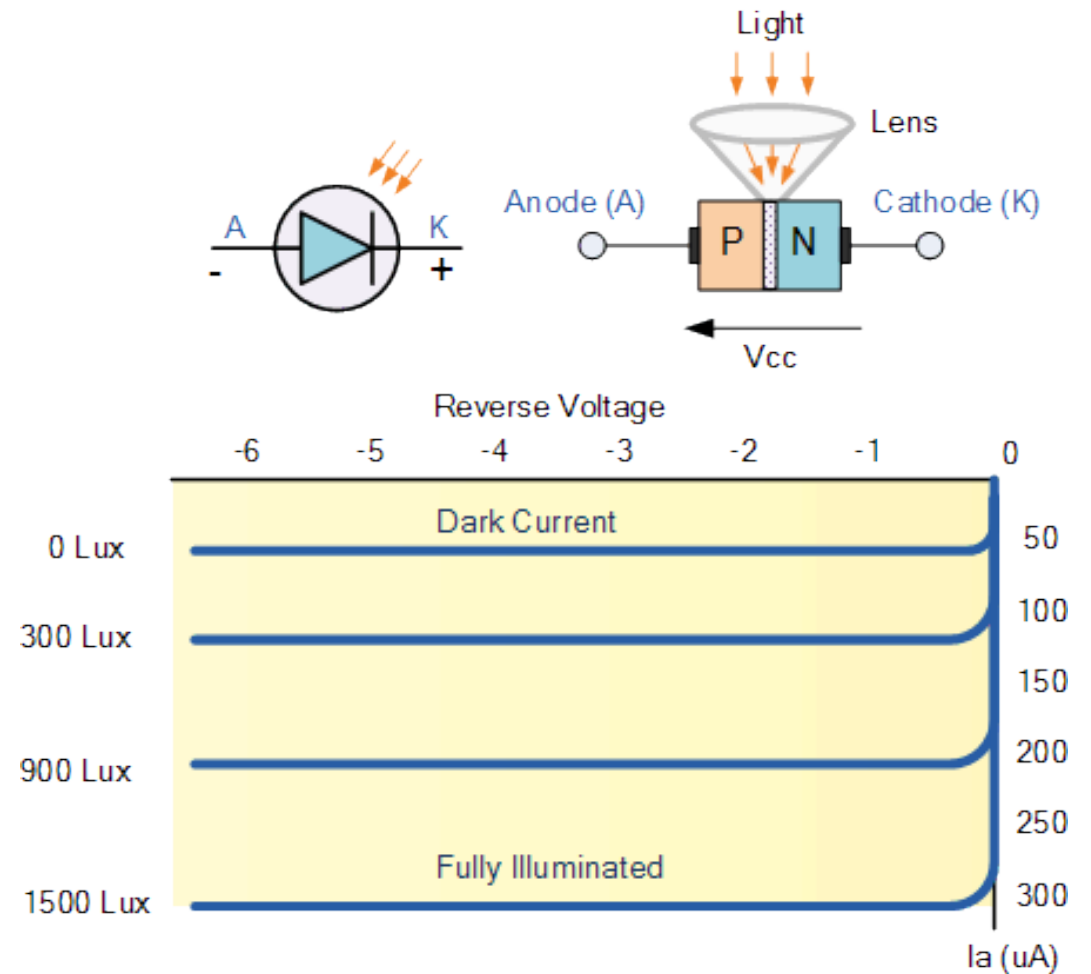

Light color sensing

- Respond to specific light colors separately

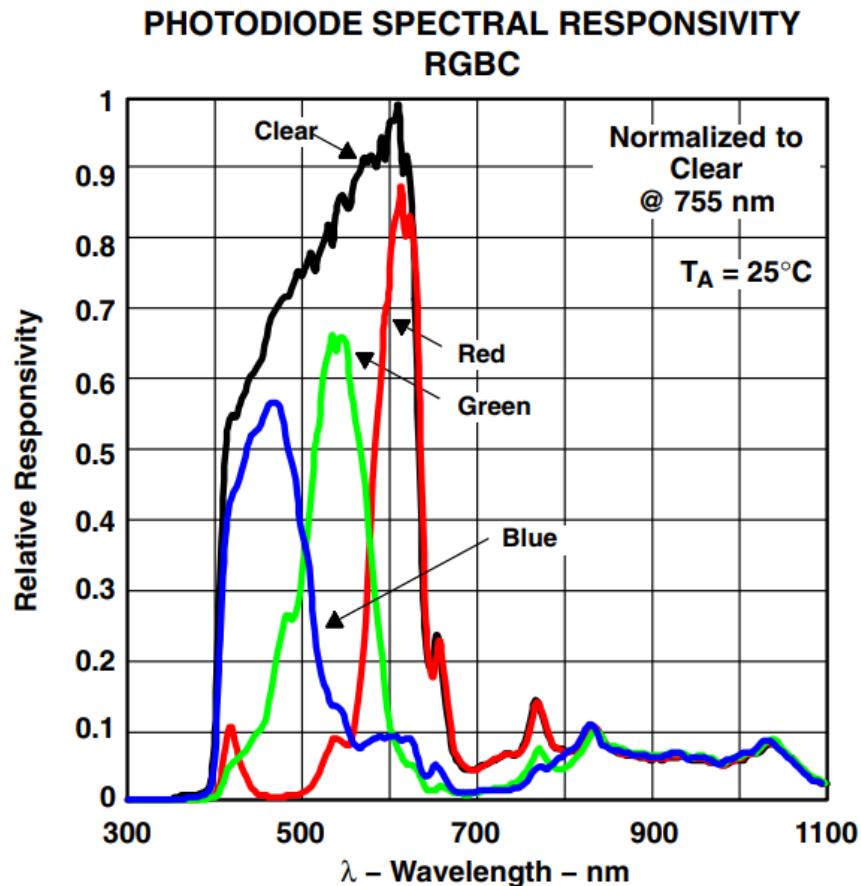

- Intelligent sensor: photodiodes combined with ADCs and a wired interface (I2C)
- Allows interrupting based on comparator too

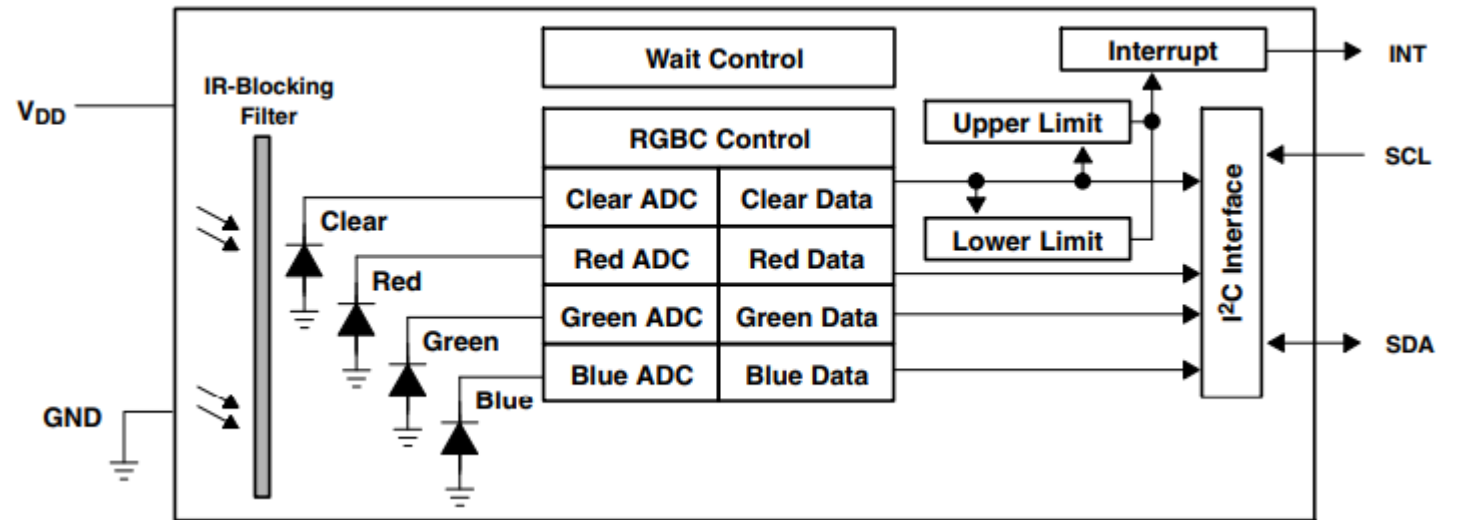

Passive Infrared (PIR) sensor

- Detect movement in the environment
 - By detecting change in IR levels
- Often come with plastic lens cover to improve field of view and range

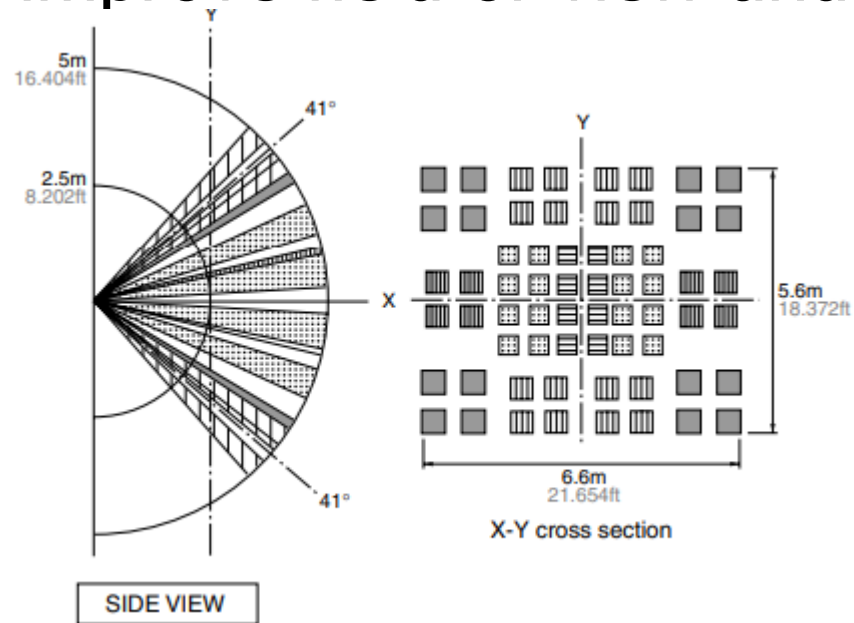

PIR sensors come in digital and analog forms

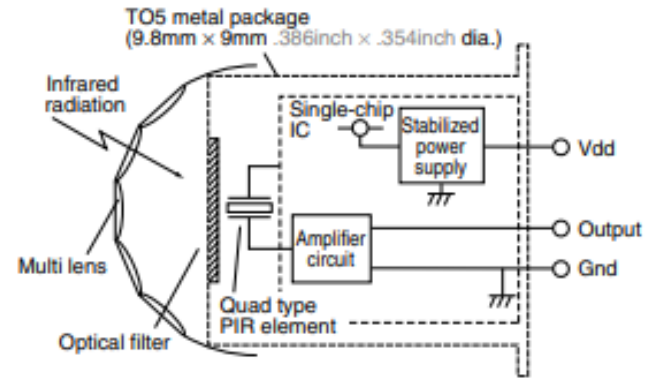
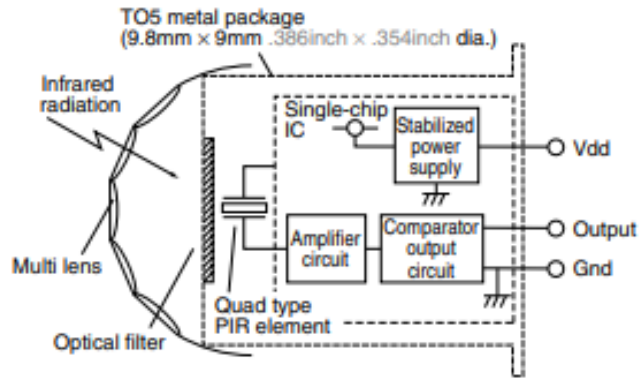

4. Timing chart

1) Digital output

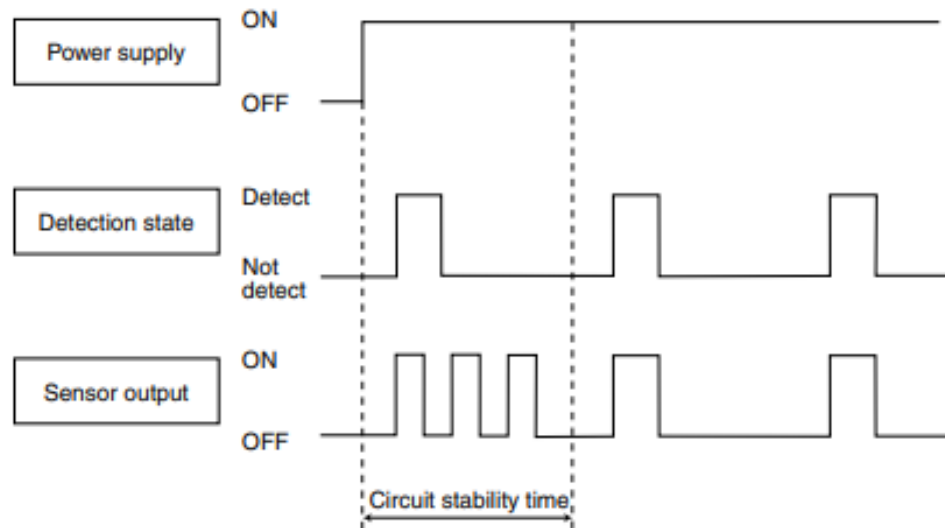

2) Analog output

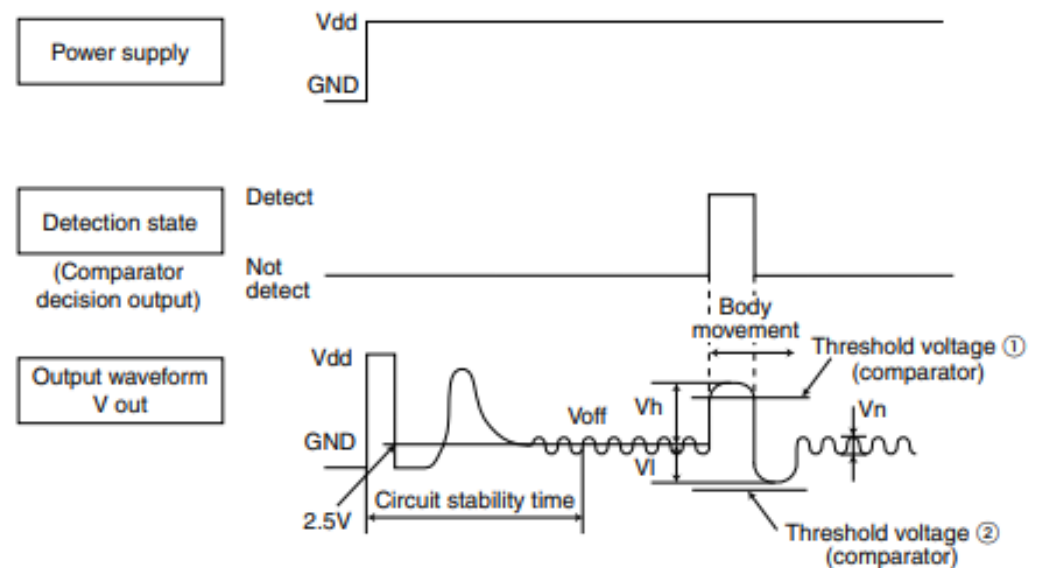

Digital includes a preconfigured comparator

Outline

- Sensing Overview
- **Types of Sensors**
 - Temperature
 - Light
 - **Inertial**
 - Others
- Research case study

Inertial Measurement Unit (IMU)

- IMUs (a.k.a 9 degree-of-freedom, 9DOF) are used for tracking motion of a device
 - Acceleration (X, Y, Z axes)
 - Rotation (X, Y, Z axes)
 - Magnetism (X, Y, Z axes)
 - Sometimes 6DOF with Acceleration + one of the others
- Intelligent sensing: combines multiple sensors, ADCs, and computation with a wired interface
 - 9 analog inputs would otherwise be too many
- Can be used to track motion, determine transportation method
 - Smartphones, Robotics, etc.

Sensing acceleration

- Goal: create a voltage that changes based on force

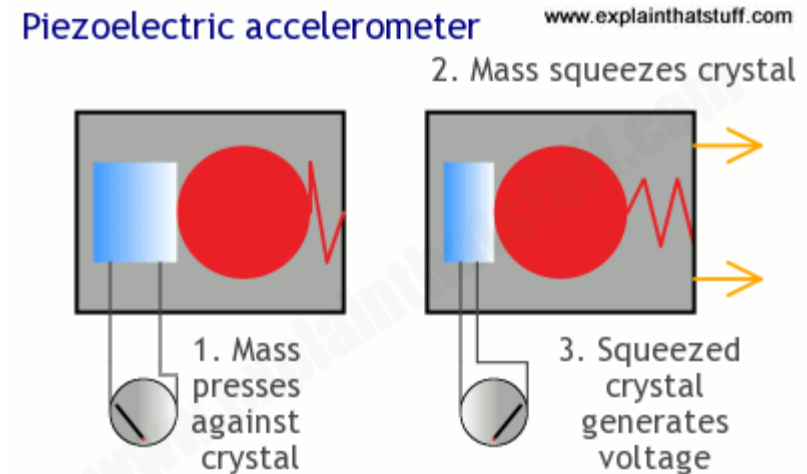
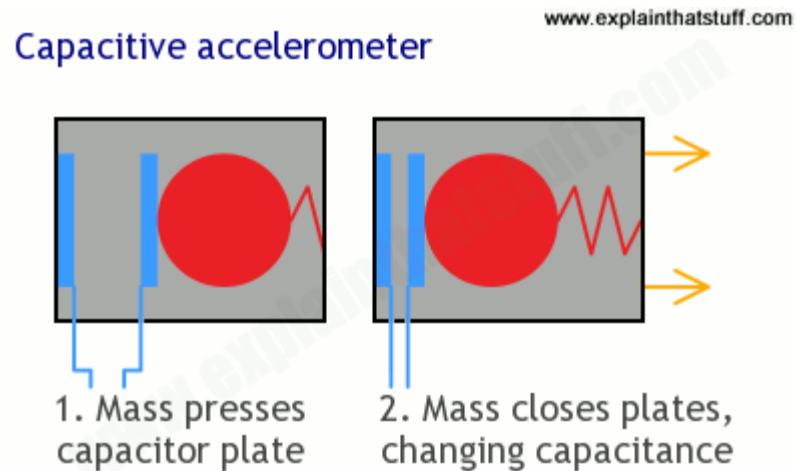

Microelectromechanical Systems (MEMS)

- Same concept, but within an IC and 1 to 100 micrometers in size

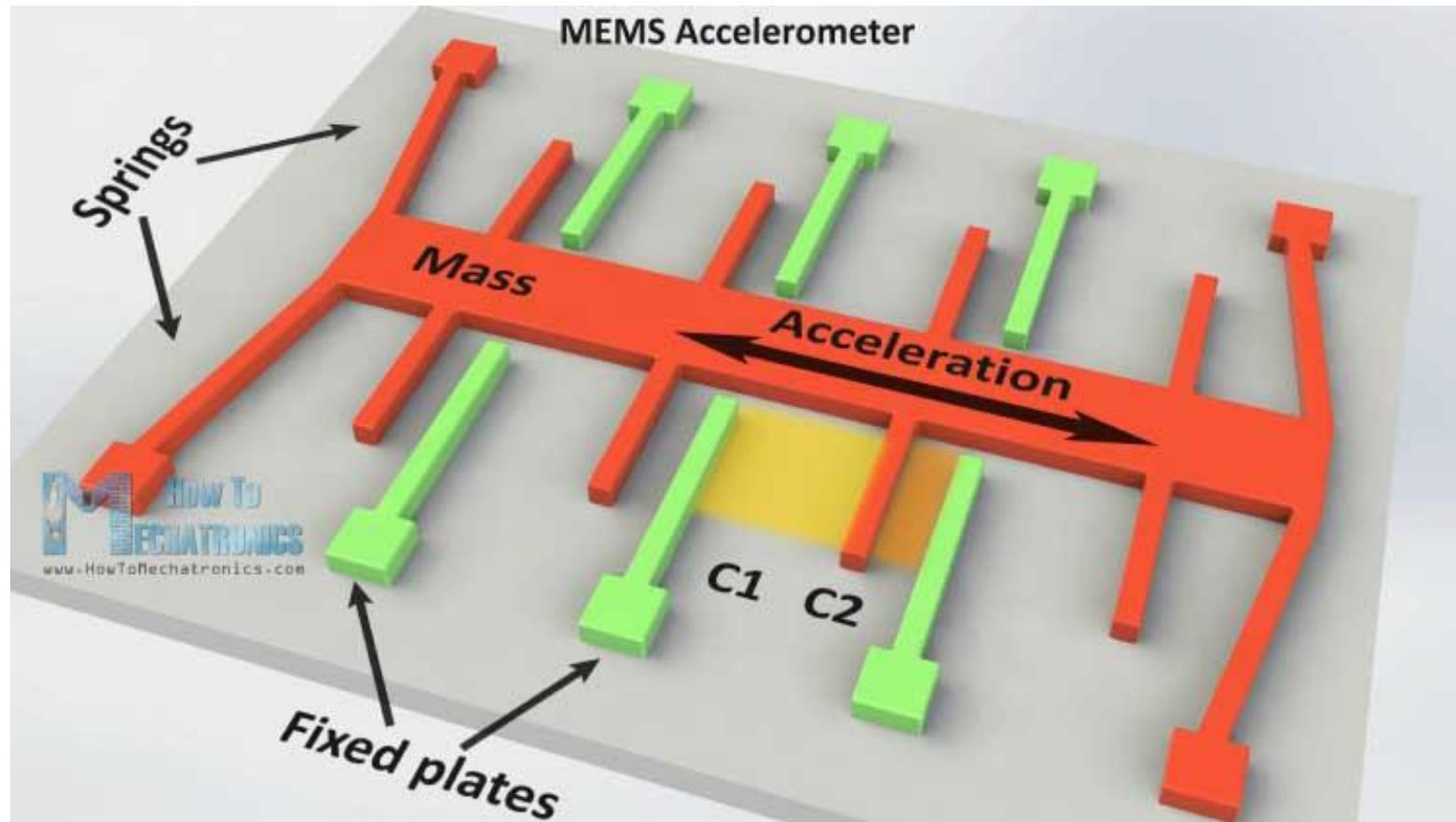

Using accelerometers

- Accelerometers usually measure in g 's
 - Where 1 g equals acceleration due to Earth gravity
- Determining distance from acceleration is possible
 - But messy. Error is squared when integrating
 - Needs careful filtering and is only accurate over short periods
 - Often fills in gaps between GPS samples (or other localization systems)
- Accelerometers also work as tilt sensors
 - Constantly sensing pull of gravity
 - $A[x] = 1g * \sin(\theta)$

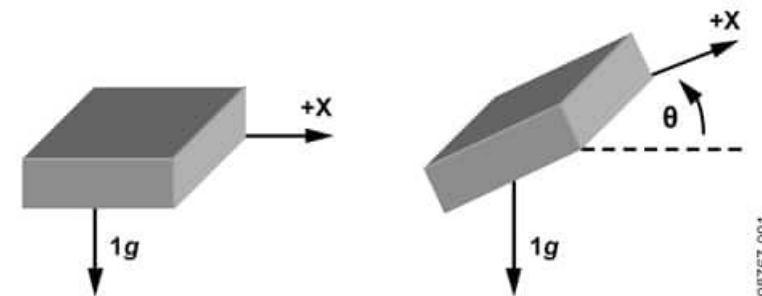

08767-001

Gyroscopes

- Measures angular velocity
 - Usually lower limit than you might hope
 - <10 rotations per second
- Usually, we want angle instead of rotation speed
 - Integrate signal to determine current angle
 - Combine noise and DC bias with integration and you get a continuously accumulating error: drift

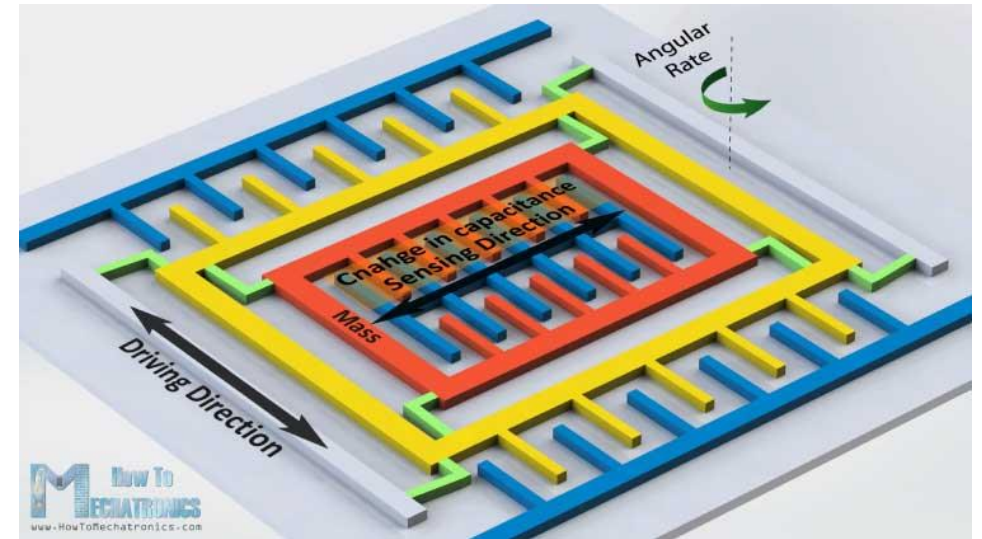

Magnetometer

- Measures the magnetic field
- Usually used in devices as a compass
 - Detect Earth's magnetic field orientation
- Problem: Earth's magnetic field often overwhelmed by local magnetism when indoors
 - Large chunks of metal in walls, for example
 - Or other metal parts nearby on the circuit board
- Satellites can use magnetometers for localization

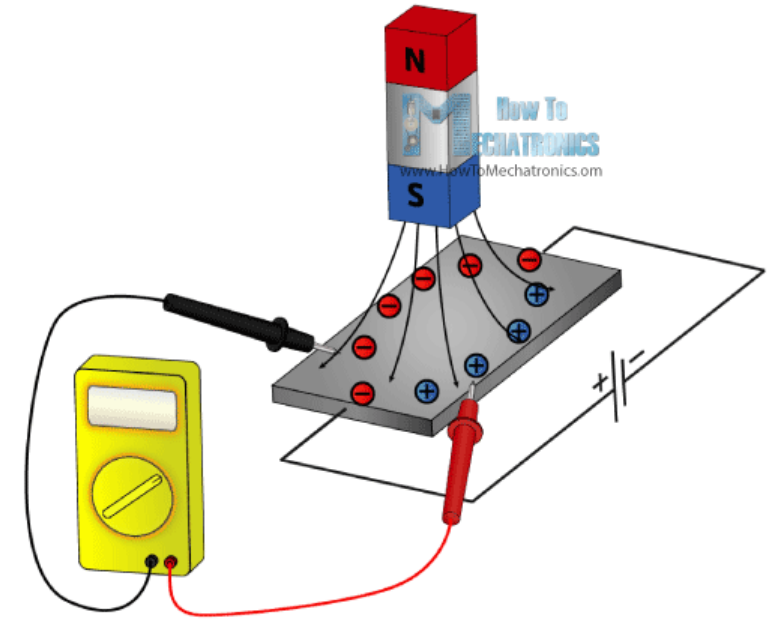

Outline

- Sensing Overview
- **Types of Sensors**
 - Temperature
 - Light
 - Inertial
 - **Others**
- Research case study

Other sensors

- Environment: Pressure, Humidity, Air Velocity, Air Quality
- Distance: Ultrasonic, Lidar, or Radar
- Biometric: Pulse Oximeter, Heart Rate
- Agricultural: Soil moisture

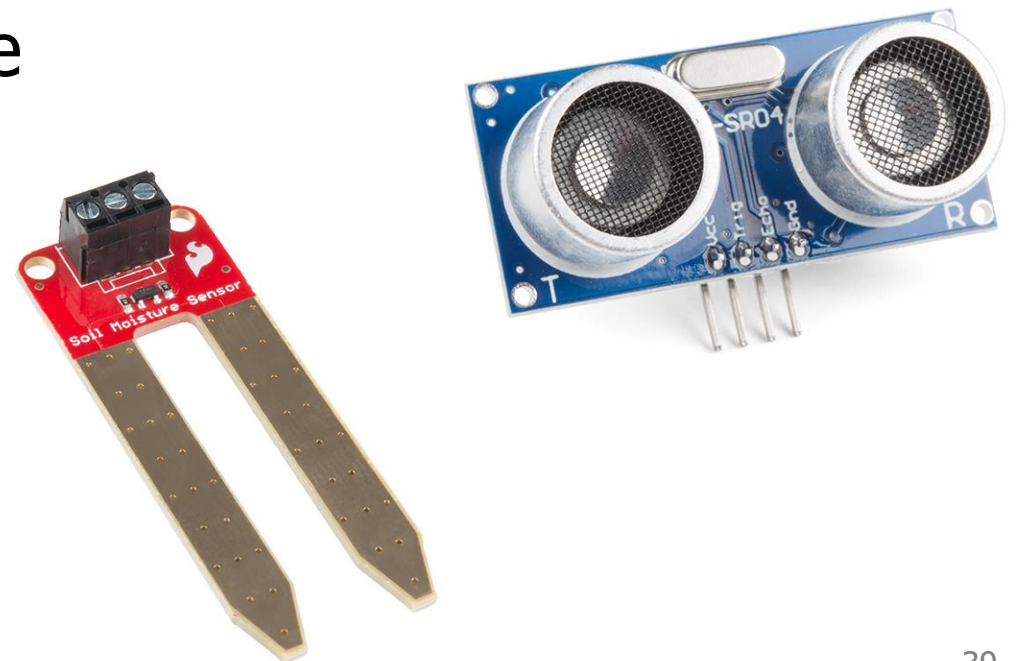

Break + Open Question

How are new sensors discovered/created?

Outline

- Sensing Overview
- Types of Sensors
 - Temperature
 - Light
 - Inertial
 - Others
- **Research case study**

PowerBlade current sensing

- Example of creating a custom sensor
- PowerBlade goals
 - Sense current and voltage in real-time
 - Be small enough to be deployable
- Problem
 - To measure current, you *usually* have to break the circuit
 - But PowerBlade attaches in parallel

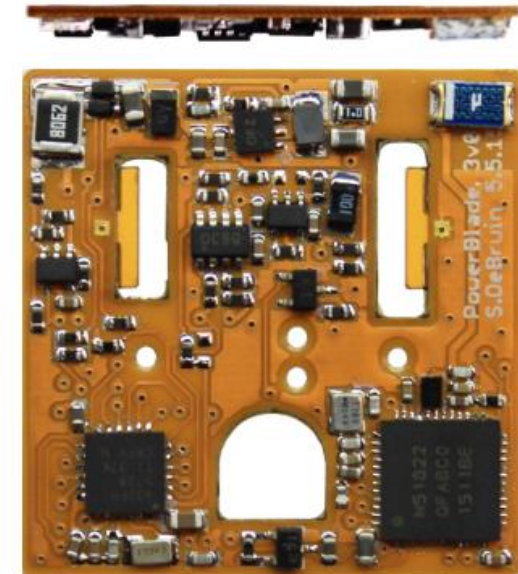

Measuring current

- Coil of wire in a changing electric/magnetic field produces a voltage
- One way to make inductors is as a coil of wire wrapped horizontally around a magnetic core
- Re-purpose horizontally wire-wound inductor as current sensor!

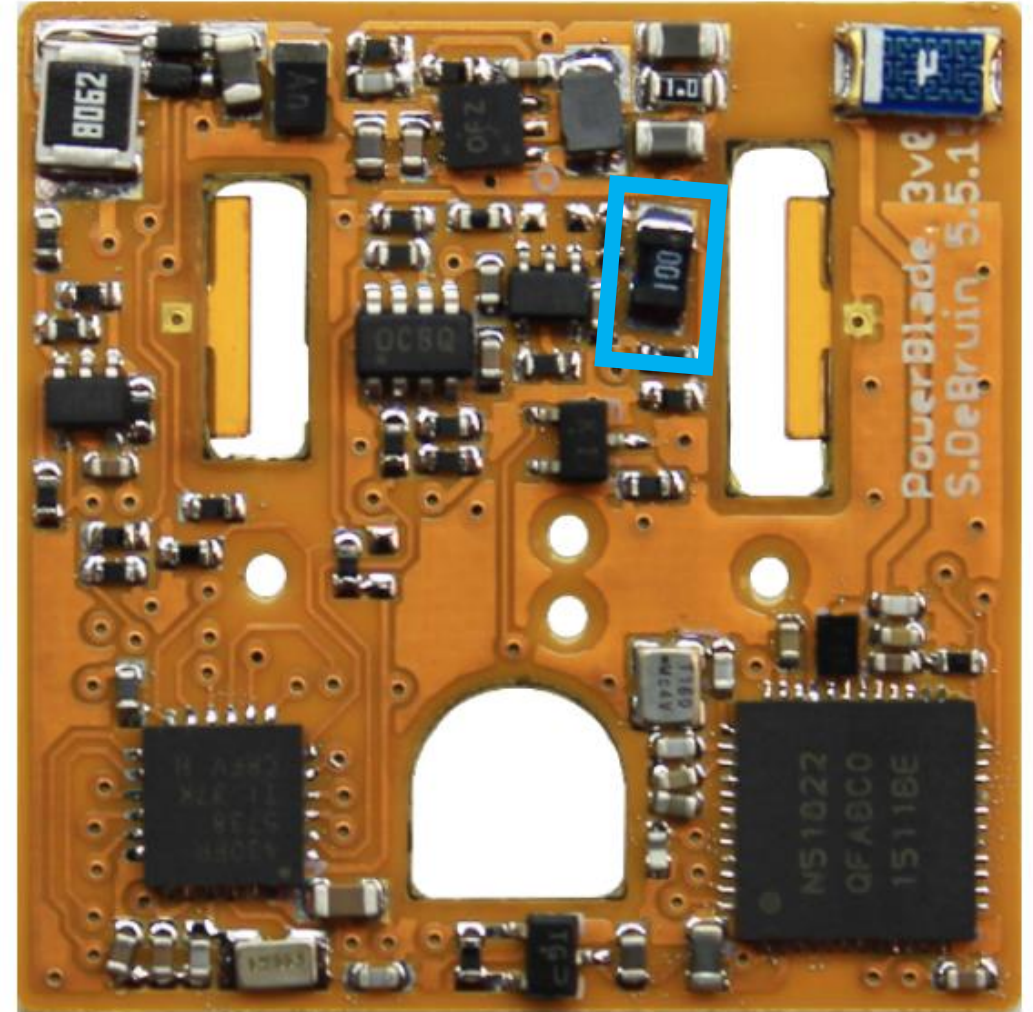

Sensor placement

- Is in the middle or close to a prong the best choice?
- Turns out it's closer to a prong
 - Decreases with distance squared
- Angled like the magnetic field is

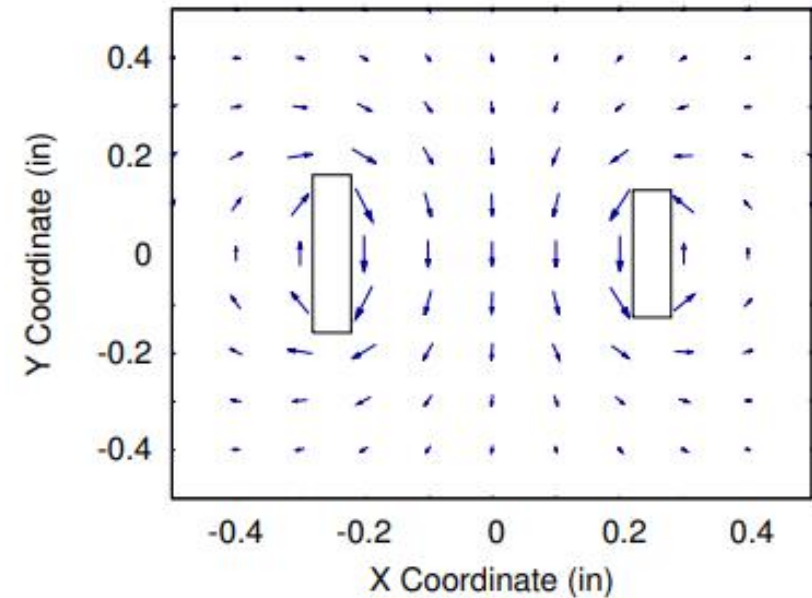
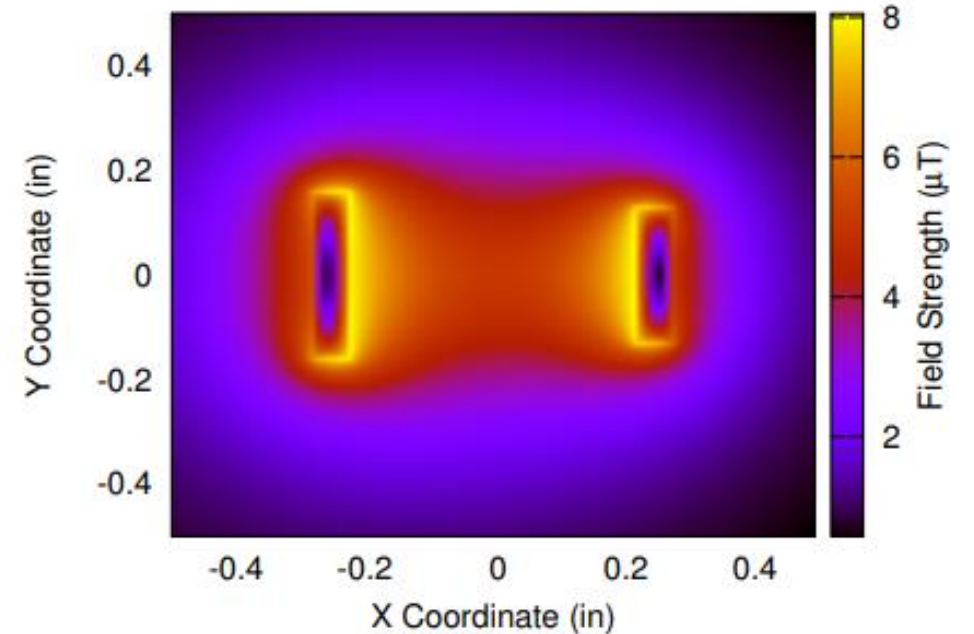

Measuring sensor values

- Sensor output is very small
- Amplify to make output large enough to accurately measure with ADC
- Need to pick sampling rate
 - AC: 60 cycles per second in US
 - Need $N * 60$ measurements per second
 - $N=42$ (as fast as we can measure)
 - 2520 measurements per second

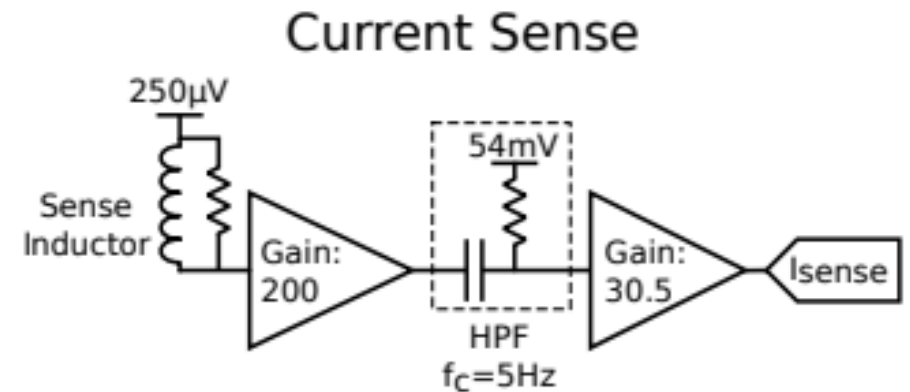

At first, our output signal was this green line

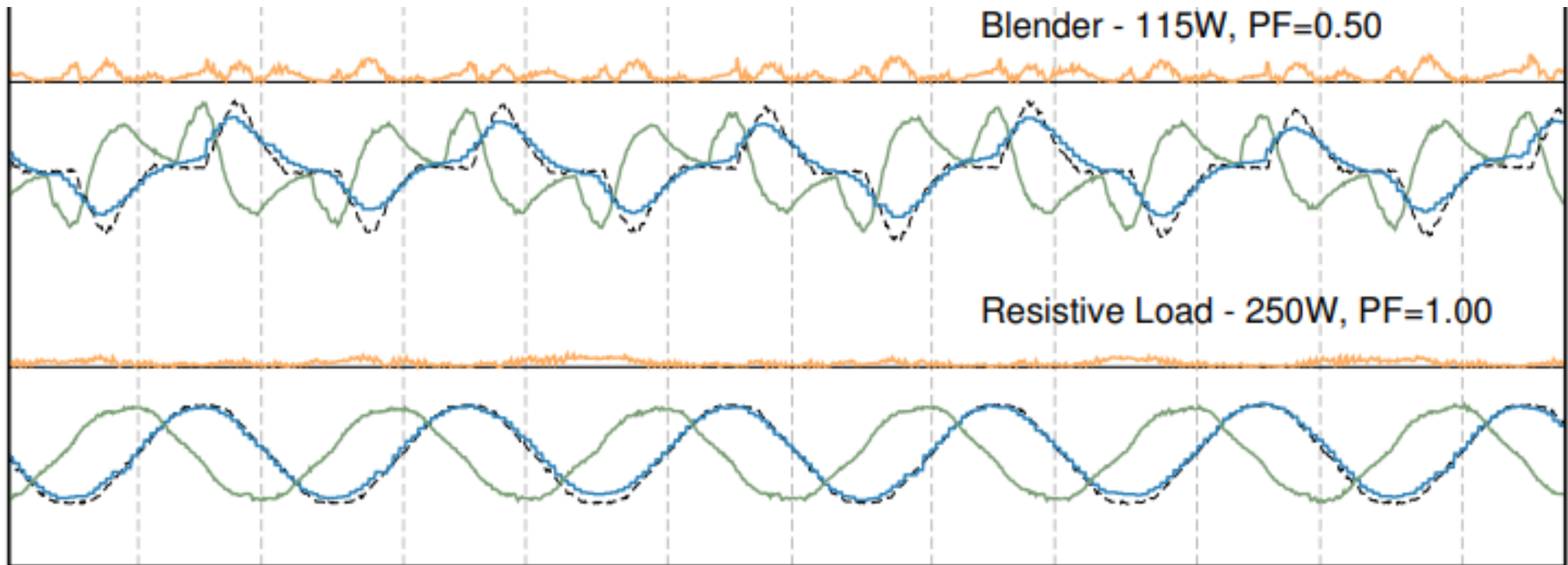

Time

Actual Current -----
Measured Current ———

I_{SENSE} ———
Absolute Error ———

Measurement into current

- Search coil measures the derivative of current!!
- Need to integrate to get signal and apply sensitivity and bias

$$\text{Current} \approx \int \left(\frac{V_{cc}}{2} + \alpha \frac{dI}{dt} \right) dt \approx \alpha I + \beta$$

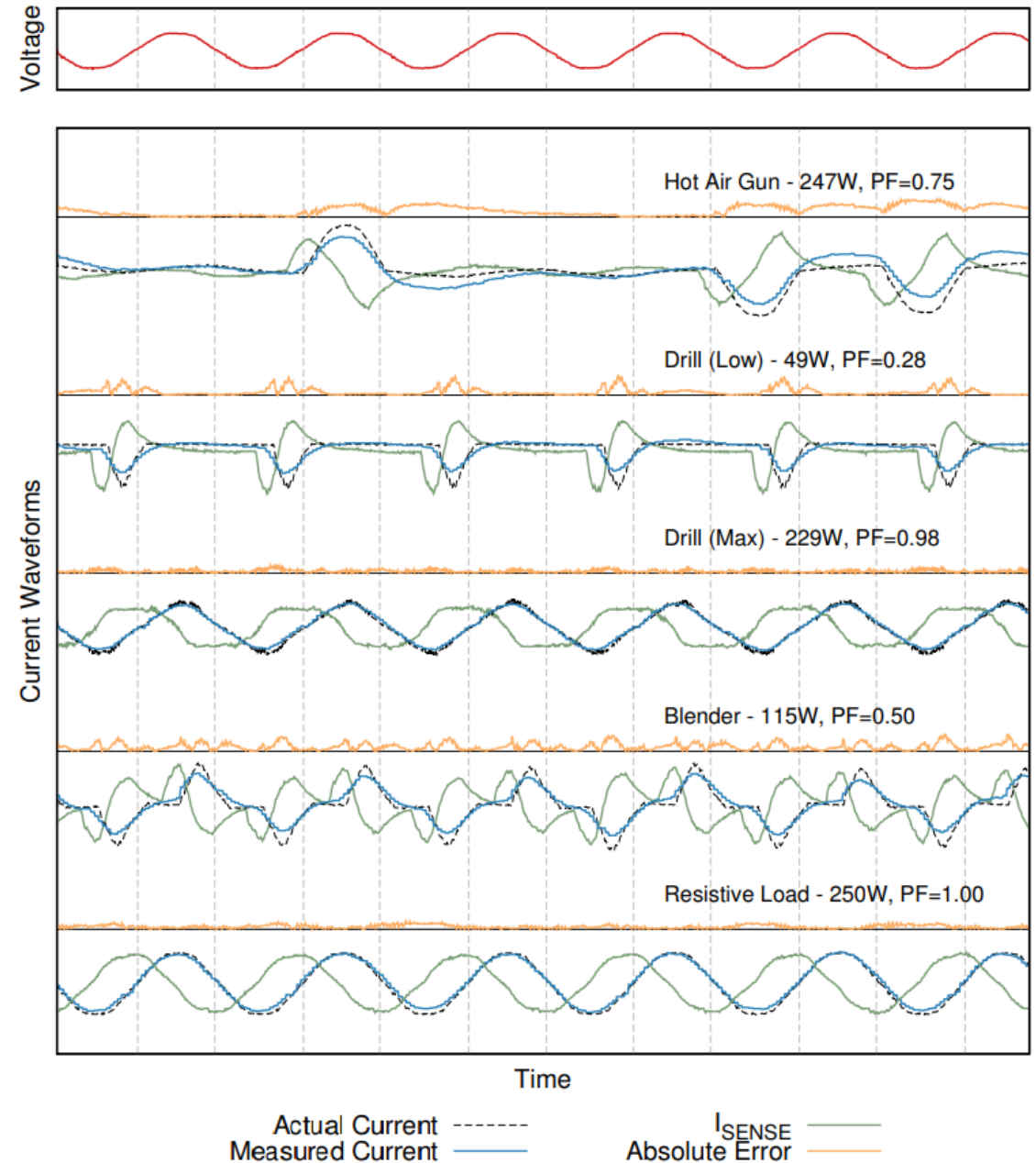

Outline

- Sensing Overview
- Types of Sensors
 - Temperature
 - Light
 - Inertial
 - Others
- Research case study